

RFXtrx

USB RF transceiver

User Guide



www.rfxcom.com

1. Table of Contents

1.	Table of Contents.....	2
2.	RFXtrx general information.....	4
2.1.	RFXtrx315 supported protocols.....	4
2.1.1.	RFXtrx315 configured for 310MHz.....	4
2.1.2.	RFXtrx315 configured for 315MHz.....	4
2.1.3.	RFXtrx868X.....	4
2.2.	RFXrec433, RFXtrx433, RFXtrx433E supported protocols.....	5
2.2.1.	By function.....	5
2.2.2.	Alphabetic list.....	10
2.3.	undec on.....	18
2.4.	Sensitivity influenced by enabled protocols.....	19
2.5.	RF range reduction.....	20
2.6.	Home Automation software.....	20
2.7.	Dimensions.....	20
2.8.	Electrical.....	20
2.9.	Environmental conditions.....	20
3.	Install the USB driver.....	21
4.	Run RFXflash on Linux under Mono.....	21
5.	RFXmngtr test program.....	22
5.1.	Receiver.....	23
5.2.	Transmitter.....	24
6.	Flash update of the RFXtrx.....	25
6.1.	Update firmware in the RFXtrx.....	25
6.2.	Update firmware in the RFXtrx step by step.....	26
7.	RFXtrx433 special device codes.....	28
7.1.	Remote commands.....	28
7.1.1.	X10 RF Remote.....	28
7.1.2.	ATI Remote Wonder.....	29
7.1.3.	ATI Remote Wonder Plus.....	30
7.1.4.	Medion Remote.....	31
7.2.	Harrison address conversion to switch settings.....	32
7.3.	Flamingo, AB400, IMPULS, Sartano, Brennenstuhl, SilverCrest 91089, Cranenbroek switch settings.....	33
7.4.	Energenie 5-gang 429.950.....	34
7.5.	Phenix, IDK YC-4000S switch settings.....	35
7.6.	HE105 switch settings.....	36
7.7.	HQ COCO-20.....	37
7.8.	MDREMOTE V106, V107.....	38
7.9.	MDREMOTE V108, EKAB-10KRF.....	38
7.10.	Aoke relay.....	38
7.11.	SEAV TXS4.....	39
7.12.	How to find the dx.com RGB LED strip driver ID.....	39
7.13.	How to find the dx.com RGB LED strip driver ID (rev. 2).....	39
7.14.	How to find the Eurodomest ID.....	39
7.15.	How to find the Screenline ID.....	40
7.16.	How to find the Avantek remote ID.....	40
8.	Blyss commands.....	41
9.	Somfy RTS.....	42
10.	BlindsT6.....	43
10.1.	Dooya DT52E, DT82TV, DT82TN.....	43
11.	Lucci Air fans.....	43
12.	Transmit undecoded ARC commands.....	44
13.	MCZ pellet stove.....	45
14.	Lighting4 devices.....	46
14.1.	Proluxx projection screen.....	46
14.2.	Kingpin (KP100) projection screen.....	46
14.3.	Mercury remote control mains sockets.....	46

14.4.	Conrad 034911 sockets	46
14.5.	Sonoff	47
14.6.	PT2262 and EV1527 oscillator resistors accepted	47
15.	Receive and Transmit RAW data	48
16.	RFXtrx433XL - P1 smart meter connection	50
17.	FAQ	51
17.1.	Receive has stopped suddenly but transmit works	51
17.2.	Can I increase the receive/transmit range of the RFXtrx?	51
17.3.	The RFXtrx USB connection disconnects sometimes.	51
17.4.	I have a 433.92MHz sensor/remote but this device is not received.	51
17.5.	The wall plug is switched by the remote, the remote is received but the RFXtrx does not switch the module.	51
18.	EC Declaration of Conformity	52
19.	Warning:	53
20.	License	53
21.	Copyright notice	53
22.	Revision history	54

2. RFXtrx general information

The RFXtrx transceivers and RFXrec receivers are communicating over an USB port with the Home Automation application. The RFXtrx/rec is powered by the USB port.

At startup the RFXtrx enters for 2 seconds the boot loader (red LED is on) and after this it starts the receive/transmit firmware. If valid (decode-able) packets are received the yellow LED will blink.

The RFXtrx315 and the RFXrec433 are mainly for use in the US. The RFXtrx315 can receive US X10 lighting and security sensors **or** US Visonic PowerCode sensors at 315MHz.

The RFXrec433 can receive weather sensors of different brands at 433.92MHz.

The RFXtrx433 is a transceiver (transmitter+receiver) and can receive and control a large number of sensors and other devices.

The RFXtrx433E is an extended RFXtrx433 transceiver.

Note: the listed protocols and brands are supported!

2.1. RFXtrx315 supported protocols

2.1.1. RFXtrx315 configured for 310MHz

Protocol	Protocol	receive	transmit
US X10 lighting	X10	Y	Y
US X10 security	X10	Y	Y

2.1.2. RFXtrx315 configured for 315MHz

Protocol	Protocol	receive	transmit
Aoke relay	Lighting5	-	Y
PT2262, EV1527 and compatibles	Lighting4	Y	Y
Keeloq (unencrypted part only)	Keeloq	Y	-
Visonic CodeSecure (unencrypted part only)	Visonic	Y	-
Visonic PowerCode	Visonic	Y	Y

2.1.3. RFXtrx868X

Protocol	Protocol	receive	transmit
Alecto ACH2010	Alecto	Y	-
FS20	FS20	Y	Y
Itho CVE RFT	Itho	-	Y
Keeloq (unencrypted part only)	Keeloq	Y	Y
Visonic CodeSecure (unencrypted part only)	Visonic	Y	-
Visonic PowerCode	Visonic	Y	-

2.2. RFXrec433, RFXtrx433, RFXtrx433E supported protocols

2.2.1. By function

Curtains, shades, projection screen, awning, gate openers
A-OK blind motors (RF01,AC114,AC123,AC127,AC129 controlled) - http://www.motorisationplus.com/
ASA ETR blind motors - http://www.asa-mingardi.org/en/home.php
ASP blind motors - http://www.asp-distribution.com/site%20volet/voletrenovation.aspx
BOFU EYB25 EY1612 blind motors - http://www.bofumotor.com/
BTX blind motors, remote, part# 490.2076 - http://www.btxinc.com
Brel blind motors - http://www.brel-motors.nl/webshop/motoren/
Chamberlain CS4330CN http://www.chamberlain24.de/epages/es122868.sf/en_GB/?ObjectPath=/Shops/es122868/Products/RA4336
Confexx CNF24-2435
Dolat DLM-1 controlled motors - http://www.dolat.com.cn/product1.asp?id=538
Dooya blind motors, remotes tested: DC305,DC306,DC307,DC313,DC1602,DC1650,DC1651,DC2700
Ematronic - http://www.ematronic.com/moteurs-volet-roulant/
ESMO blind motors
Forest blind/curtain motors - http://www.forestgroup.nl/index_nl.html
Harrison curtain - http://www.harrison.nl/home2.htm
Hasta blind motors - http://www.hasta.se/
JVS screens - http://www.screen-discount.nl/
Kimex projection screen - https://www.kimexinternational.com/A-9162-ecran-de-projection-electrique-encastrable-3-00-x-1-69m-format-16-9.aspx
Kingpin KP100 projection screen
Louvolite one touch motorised blinds
Luxaflex (RFXtrx433E only) - http://www.luxaflex.se/produkter/luxaflex/rullgardiner/
Media Mount Projector screen
Motolux - http://www.motolux.com.au/
Nobily rolladenmotor http://www.nobily.de/rolladenmotor/funk-elektronisch/40mm-achtkantwelle/170/nobily-rolladenmotor-pre4?c=5
Outlook Motion Blinds - https://www.spotlightstores.com/curtains-blinds/indoor-blinds/roller-blinds/project-outlook-motion-motorised-roller-blind/p/BP80360543
Proluxx projection screen
Quotidom - http://www.quotidom.com/moteur-tubulaire-radio-quotidom-10-ou-20-nm-volet-roulant-ou-store-banne.html (not the Solutio version)
RAEX blind motor (YR1326 controlled)
RohrMotor24 RMF blind motors - http://www.rohrmotor24.eu/rohrmotor24
RollerTrol blind motors - http://rollertrol.com/
Screenline motors - http://www.screenline.cz/en/
Silverline Premium - http://www.aluparts.nl
Simu (RFXtrx433E only) - http://www.simu.com/
Somfy (RFXtrx433E only) - http://www.somfy.co.uk/
Sunflower brand KT52E motorized Curtain track,Single track, DOOYA motor https://nl.aliexpress.com/item/motorized-Curtain-track-1m-3-3m-wide-Single-track-DOOYA-motor-the-top-motor-brand-in/1939622604.html
Sunpery blind motors
YOODA blind motors - http://www.sukcesgroup.pl

Temperature, humidity, weather sensors
Alecto – WSD10, WS1200, WS1700, WS3500, WS4500
Auriol – H13726
Ambient Weather - F007TH
Banggood – SKU174397 http://www.banggood.com/433MHz-Wireless-Weather-Station-Digital-Thermometer-Humidity-Sensor-p-965559.html
Blyss 630467
Cresta
Digimax
Digoo DG-R8H
Froggit - F007TH
Hama – EWS1500
Hideki weather sensors
Honeywell – TF-ATS34C
Inovalley SM80 with plant probes - http://www.inovalley.com/detail.php?item_id=289
La Crosse
Lexibook – SM883
Marquant 943134
Maverick ET-732, ET-733 BBQ/Smoke temperature
Meade – TS33F-M, TS34C-M http://www.meade.com/products/weatherstations/sensors.html
Meteoscan – W155, W160
Nexa NBA-001
NEXUS – I008T
mi.sol WH2 http://www.ebay.com/itm/Transmitter-for-Wireless-Weather-Station-wireless-temperature-sensor-/121664060899
Opus XT300 /Imagintronix Soil sensor http://www.plantcaretools.com/en/webshop/wireless-moisture-sensor-en-detail http://www.ebay.co.uk/itm/Wireless-Soil-Moisture-Sensor-/251380900939?pt=UK_Home_Garden_Plants_Fertiliser_CV&hash=item3a8778244b
Oregon Scientific / Huger
Pearl NC-7159 http://www.pearl.de/a-NC7159-3041.shtml
Prego P-8426 http://www.sunmarket.fi/tuote.asp?TID=11990
Proove –TSS320 & TSS330 fridge/freezer thermometer & outdoor sensors 311346,311501
RFXSensor
RUBiCSON – stektermometer 48659, 48695 –pool sensor p48019
Sunvic TLX1206
Sunvic TLX7506
TechnoLine/Proficell http://www.elv.de/output/controller.aspx?cid=74&detail=10&detail2=27621 - TX95-TH, WS9180-TX104
Telldus Thermo/Hygro sensors 313159 and 313160 https://www.lohelectronics.se/hemautomation/433mhz/sensorer-1110/smart-inne-och-utetermometer-med-hygrometer-10396
TFA
UPM/Esic (very short receiving range)
Ventus – WS155
Viking
WT0122 pool thermometer
Xiron –EN6

Door/window, smoke and other security sensors
Aidebao security
Alecto – SA30, SA33 smoke detector
AliExpress sensors with EV1572 or PT2262 (PT2262 is preferred)
Atlantic security
Chacon KD101 smoke detector
Chuango security
Eminent security
Flamingo KD101 smoke detector FA20RF, FA21RF
Focus
Housegard Origo smoke detector
Kerui security https://www.aliexpress.com/item/433-MHz-Wireless-Door-Windows-Sensors-for-KERUI-Alarm-System-Magnetic-Door-Sensor-Door-Open-reminder/32590916896.html
Meiantech security
NEXA KD101/LM101LC smoke detector
Renkforce RF101 smoke detector
Smartwares RM174RF smoke detector
Oregon MSR939 https://www.redealer.de/multimedia/home-living/wetterstationen/bewegungssensor-msr939/a-200667/
Visonic CodeSecure
Visonic PowerCode
X10 security

Appliance modules, dimmers, relays, LED controllers
ANSLUT (learning mode)
Aoke relay http://www.aliexpress.com/store/product/whose-sale-prices-DC12V10A-Learning-Code-Wireless-Remote-Control-Switch-System-1-Receiver-and-1-Transmitter/1211856_1774391429.html
Avantek
ByeByeStandBy
Blyss lighting – http://www.castorama.fr/store/Prise-telecommandee-et-telecommande-BLYSS---Interieur-prod4470026.html
Brennenstuhl RC2044, RCS2044N
Chacon – http://www.chacon.be/
CoCo – http://www.coco-technology.com/en/home/
Conrad RSL2 – http://www.conrad.com/ce/en/product/640466/FUNK-STECKDOSENSCHALTER-RSLR2
Cotech Smarhome
Cranenbroek
DI.O – http://www.di-o.be/
DomiaLite
Ebode
ELRO AB400/AB600 – http://www.elro.eu/en/products/cat/home-automation/home-control1
Energenie ENER010 – 429.935, 5-gang 429.950 - https://energenie4u.co.uk/
Etekcity – http://etekcity.com/p-300-5-pack-wireless-remote-control-outlet-switch-set-with-2-remote-controls-zap-5lx.aspx
Eurodomest NL – Action
Everflourish EMW100
Flamingo
Flamingo FA500D FA500DSS
Flamingo Smartwares SF501
FunkBus (Gira, Jung, Insta, Berker)
Home Confort – http://www.home-confort.net/en
HomeEasy EU – http://www.elro.eu/en/products/cat/home-automation/
HomeEasy UK (including HE105 relay) – http://www.homeeasy.eu/
HQ COCO-20
Ikea Koppla
Impuls – NL – Action
Intertechno – http://www.intertechno.at/
Kambrook RF3672 – http://www.bunnings.com.au/kambrook-4-piece-indoor-powerpoint-kit-with-remote-control_p7030054

KlikAanKlikUit – http://www.klikaanklikuit.nl/home/
Legrand CAD radio – http://docdif.fr.grpleg.com/general/legrand-fr/NP-FT-GT/FA181DFR.pdf
LightwaveRF – http://www.lightwaverf.co.uk/
Livolo - http://www.livolo-france.com/fr/ http://nl.aliexpress.com/w/wholesale-livolo-touch-switch.html
Maplin http://www.maplin.co.uk/p/remote-controlled-mains-socket-set-single-n78ka (use Lighting1 – COCO GDR2)
MDremote LED dimmer V106, V107, V108, EKAB-10KRF - www.ultraleds.co.uk - http://www.ledstripkoning.nl/accessoires/dimmers-wit/draadloze-dimmer-10-knops-rl/
Mercury appliance modules – http://mercury.avsl.com/product?range=ME5124
NEXA – http://www.nexa.se/
ORNO
OTIO
Phenix
Philips SBC SP370 series
Profile Qnect 423000040,423000042
PROmax
Proove - http://proove.se/
Quigg
RGB LED strip driver dx.com - http://www.dx.com/ order nbr: 130913 (new TRC02 not supported) , 67412
RisingSun
Sartano
Siemens (UK)
SilverCrest 91089, 60494, 284705
Unitec 48110 EIM 826
Waveman
X10 RTS10 / RFS10
X10 lighting
Xdom

Remotes
ATI Remote Wonder
ATI Remote Wonder Plus
ATI Remote Wonder II
SEAV TXS4
X10 PC Remote

Chimes
1byOne Easy Chime
Byron SX chime - http://www.chbyron.eu/Byron/ByronSXRange/68/89/
Byron MP001
Chacon
Envivo – ENV1348
HomeEasy
KlikAanKlikUit
Profiles PAC-326R Belcanto
SelectPlus200689101 & SelectPlus200689103 (Action NL)

Power, gas water metering
Cartelectronic TIC, Encoder, Linky - https://www.cartelectronic.fr/index.php?id_product=124&controller=product
cent-a-meter
Electrisave
OTIO EHS5050
OWL CM113, CM180, CM119, CM160, CM180, CM180i - http://www.theowl.com/
Revolt NC5461 - http://www.pearl.de/a-NC5462-5452.shtml
RFXMeter

Specials
1byone Wireless Home Security Driveway Alarm http://www.1byone.co.uk/Home-Security/Alarms/O00QH-0511
DEA receivers http://www.deasystem.com/en/accessory/7/receivers (unencrypted only)
Lucci Air Fan - http://www.lucciair.com/
MCZ pellet stove
Mertik Maxitrol – Fire Place controllers
Oregon Scientific Body weight scales – BWR101, BWR102, GR101
Prego P-8426 – sauna temperature sensor http://www.sunmarket.fi/tuote.asp?TID=11990
Smartwares radiator valve http://www.homewizard.nl/smartwares-draadloze-radiatorkraan.html
Siemens SF01 - LF959RA50/LF259RB50/LF959RB50 extractor hood
Wave Design extractor hood
X10 Ninja/Robocam – camera motor

2.2.2. Alphabetic list

Important notes:

- Ext, Ext2, Pro1 and Pro2 firmware can only be used in the RFXtrx433E!
- ProXL firmware can only be used in the RFXtrx433XL!
- RFXrec firmware is equal to RFXtrx433 – Type1 firmware without the transmit functions.
- Protocol enabling is only necessary for receive. Transmit protocols are always enabled.
- R = Receive only
- T = Transmit only
- RT = Receive & Transmit

Device	Type 1	Type 2	Ext	Ext 2	Pro 1	Pro 2	ProXL 1	Protocol
1byone Driveway Alarm http://www.1byone.co.uk/Home-Security/Alarms/O00QH-0511		RT	RT	RT	RT	RT	RT	ByronSX
1byone Easy Chime		RT	RT	RT	RT	RT	RT	ByronSX
A-OK blind motors RF01 http://www.motorisationplus.com/	RT	RT		RT	RT	RT	RT	BlindsT2
A-OK blind motors AC114,AC123,AC127,AC129, ZC11 - http://www.motorisationplus.com/	RT	RT		RT	RT	RT	RT	BlindsT3
Aidebao security	RT	RT	RT	RT	R	R	R	Meiantech
Alecto – SA30, SA33 smoke detector	RT		RT				RT	Oregon
Alecto – WS1200	R	R	R	R	R	R	R	LaCrosse
Alecto – WS1700 and compatibles, WS3500, WS4500			R	R	R	R	R	Rubicson
Alecto – WSD10				R	R	R	R	Rubicson
Ambient Weather F007TH, WS14 pool sensor				R	R	R	R	Oregon
ANSLUT (learning mode)	RT	RT	RT	RT	RT		RT	AC
Aoke relay http://www.aliexpress.com/store/product/who-se-sale-prices-DC12V10A-Learning-Code-Wireless-Remote-Control-Switch-System-1-Receiver-and-1-Transmitter/1211856_1774391429.html	RT	RT	RT	RT	RT		RT	Lighting5 Aoke or Lighting1 ARC
ASA ETR blind motors - http://www.asa-mingardi.org/en/home.php			T	T	T	T	T	RFY
ASP blind motors http://www.asp-distribution.com/site%20volet/voletrenovation.aspx	RT	RT		RT	RT	RT	RT	BlindsT11
ATI Remote Wonder	R							ATI
ATI Remote Wonder Plus	R							ATI
ATI Remote Wonder II (only available in hardware version 1.0)	R							ATI
Atlantic security	RT	RT	RT	RT	RT	RT	RT	Meiantech
Auriol H13726			R	R	R	R	R	Rubicson
Auriol Z31055B-TX				R	R	R	R	Rubicson
Avantek * receive Lighting4			RT	RT	RT	RT	RT	Lighting5 *Lighting4
Banggood – SKU174397			R	R	R	R	R	Rubicson
Banggood DANIU			R					Rubicson
ByeByeStandBy	RT	RT	RT				RT	ARC
Byron SX chime http://www.chbyron.eu/Byron/ByronSXRRange/68/89/	RT	RT	RT	RT	RT	RT	RT	ByronSX
Byron MP001 chime			T	T			T	Chime Byron MP001
Blyss lighting http://www.castorama.fr/store/Prise-telecommandee-et-telecommande-BLYSS---Interieur-prod4470026.html	RT	RT	RT		RT		RT	AE
Blyss temperature/humidity 630467	R	R	R				R	AE

Device	Type 1	Type 2	Ext	Ext 2	Pro 1	Pro 2	ProXL 1		Protocol
BOFU EYB25 EY1612 blind motors - http://www.bofumotor.com/ * = receive only in Type2 used to get the remote ID.	T	RT	T	T	T		RT		BlindsT0
Brennenstuhl RCS2044N	RT	RT	RT	RT	RT	RT	RT		Lighting4
Brennenstuhl RC2044				RT	RT		RT		Lighting4 + AC Pro1 AC
Brel blind motors http://www.brel-motors.nl/webshop/motoren/	T	T	T	T	RT	RT	RT		BlindsT6
BTX blind motors, remote, part# 490.2076 http://www.btxinc.com		T					T		BlindsT9
CarteElectronic TIC, Encoder, Linky https://www.cartelectronic.fr/index.php?id_pr oduct=124&controller=product		R		R	R	R	R		ATI/cartelectronic
casafan					T	T	T		Fan Casafan
cent-a-meter	R	R	R						Oregon
Chacon (learning mode) http://www.chacon.be/	RT	RT	RT	RT	RT	RT	RT		AC
Chacon (with address code wheels)	RT	RT	RT	RT	RT		RT		ARC
Chacon EMW200	T	T	T				T		Lighting1 EMW200
Chacon 54660 (equal COCO GDR2)	T	T	T	T			T		Lighting1 COCO GDR2
Chacon KD101 smoke detector	RT	RT	RT	RT	RT	RT	RT		always on
Chamberlain CS4330CN http://www.chamberlain24.de/epages/es122868.sf/en_GB/?ObjectPath=/Shops/es122868/Products/RA4336			T				T		BlindsT8
Chuango * decoded as X10	R	R	R	R*	R*	R*	R*		Lighting4
CoCo (learning mode) http://www.coco-technology.com/en/home/	RT	RT	RT	RT	RT	RT	RT		AC
CoCo (with address code wheels)	RT	RT	RT	RT	RT		RT		ARC
CoCo GDR2 (equal Chacon 54660)	T	T	T	T			T		Lighting1 COCO GDR2
Confexx CNF24-2435				T			T		BlindsT12
Conrad RSL2 http://www.conrad.com/ce/en/product/640466/FUNK-STECKDOSENSCHALTER-RSLR2	RT	RT		RT	RT		RT		RSL
Conrad RSL sensors		R					R		RSL
Conrad RSL2 motion/door-window sensors		R					R		RSL
Cotech Smarthome				RT	RT		RT		Lighting4 + AC,
Cotech weather sensor https://www.clasohlson.com/no/Ekstra-temperaturgiver-hygrometer/36-6726				R	R		R		Rubicson
Cranenbroek	T	T	T	T			T		Lighting1 Impuls
Cresta - TX-320, TS34C, anemometer, UV sensor, rain sensor	R	R	R	R	R	R	R		Hideki
Cuveo https://shop-m-e.de/produkte/cuveo-funk-system/?p=1						RT	RT		AE
DEA receivers (unencrypted) http://www.deasystem.com/en/accessory/7/receivers			RT		RT	RT	RT		KeeLoq
Digimax	R	R	R	R	R		R		X10
Digoo DG-R8H				R	R	R	R		Rubicson

Device	Type 1	Type 2	Ext	Ext 2	Pro 1	Pro 2	ProXL 1	Protocol
https://www.banggood.com/Digoo-DG-R8H-433MHz-Wireless-Digital-Hygrometer-Thermometer-Weather-Station-Sensor-for-TH11300-8380-p-1178108.html								
DI.O (learning mode) http://www.di-o.be/	RT	RT	RT	RT	RT	RT	RT	AC
DI.O (with address code wheels)	RT	RT	RT	RT	RT		RT	ARC
Dolat DLM-1 controlled motors http://www.dolat.com.cn/product1.asp?id=538		T					T	BlindsT10
DomiaLite (with address code wheels)	RT	RT	RT	RT	RT		RT	ARC
Dooya blind motors, emulate remotes: DC305,DC306,DC307,DC313,DC1602,DC1650,DC1651, DC2700	T	T	T	T	RT	RT	RT	BlindsT6
Ebode	RT	RT	RT	RT	RT	RT	RT	X10
Electrisave	R	R	R		R	R	R	Oregon
ELRO AB400 http://www.elro.eu/en/products/cat/home-automation/home-control1	RT	RT	RT	RT	RT		RT	Lighting4
ELRO AB600	RT	RT	RT	RT	RT		RT	ARC
Ematronic RF01 http://www.ematronic.com/moteurs-volet-roulant/	RT	RT		RT	RT	RT	RT	BlindsT2
Ematronic AC114, AC123 http://www.ematronic.com/moteurs-volet-roulant/	RT	RT		RT	RT	RT	RT	BlindsT3
Eminent * decoded as X10 in ext firmware	RT	RT	RT	RT	RT	RT	RT	Lighting4
Energenie https://energenie4u.co.uk/ - ENER010 – 429.935, 5-gang 429.950	T	T	T				T	Lighting1 Energenie Energenie5
Envivo – Chime ENV1348			T					Chime Envivo
ESMO blind motors	T	T	T	T	RT	RT	RT	BlindsT6
Etekcitcity – http://etekcity.com/p-300-5-pack-wireless-remote-control-outlet-switch-set-with-2-remote-controls-zap-5lx.aspx	T	T	T				T	Lighting1 Energenie5
Eurodomest (NL – Action) * ARC only	T*	T	T*	T*			T	Lighting1 ARC Or Lighting5 Eurodomest
Everflourish EMW100	T	T	T				T	Lighting5 EMW100
Faro Barcelona fan – http://www.faro.es/			T		T	T	T	Fan LucciAir
Faro Barcelona DC fan For example : Airfusion Climate II 50 DC					T	T	T	Fan LucciAir DC
Faro Barcelona DCII fan For example : Airfusion Climate II 50 DC					T	T	T	Fan LucciAir DCII
Flamingo	RT	RT	RT	RT	RT	RT	RT	Lighting4
Flamingo FA500D FA500DSS				T	T		T	IT
Flamingo KD101 smoke detector FA20RF, FA21RF	RT	RT	RT	RT	RT	RT	RT	always on
Flamingo Smartwares SF501	R	R	R	R	R	R	R	AC
Focus	RT	RT	RT	RT	RT	RT	RT	Meiantech
Forest blind/curtain motors http://www.forestgroup.nl/index_nl.html	T	T	T	T			T	BlindsT7
Froggit - F007TH				R	R	R	R	Oregon
FT1211R fan controller					T	T	T	Fan FT1211R
FunkBus (Gira, Jung, Insta, Berker)						RT	RT	Funkbus
HAMA EWS1500			R	R	R	R	R	Rubicson
Harrison curtain http://www.harrison.nl/home2.htm	T	T	T	T	T		T	Curtain Harrison

Device	Type 1	Type 2	Ext	Ext 2	Pro 1	Pro 2	ProXL 1		Protocol
Hasta new blind motors http://www.hasta.se/ * = receive only in Type2 used to get the remote ID.	T	RT	T	T	T		RT		BlindsT0
Hasta old blind motors	RT	RT					RT		BlindsT1
Hideki weather sensors	R	R	R	R	R	R	R		Hideki
Home Confort lighting http://www.home-confort.net/en			RT				RT		HomeConfort
HomeEasy EU (learning mode) http://www.elro.eu/en/products/cat/home-automation/	RT	RT	RT	RT	RT	RT	RT		HE EU
HomeEasy UK – HE105 - http://www.homeeasy.eu/	T	T	T	T			T		Thermostat2 HE105
HomeEasy UK (learning mode)	RT	RT	RT	RT	RT	RT	RT		AC
HomeEasy UK (with address code wheels)	RT	RT	RT	RT	RT		RT		ARC
Honeywell - TF-ATS34C	R	R	R	R	R	R	R		Hideki
Housegard Origo smoke detector				RT	RT		RT		ARC
HQ COCO-20			T	T			T		Lighting1 HQ COCO20
Hualite blinds					T	T	T		BlindsT14
Ikea Koppla	T								Lighting3
Impuls (NL – Action)	T	T	T	T			T		Lighting1 Impuls
Inovalley SM80 with plant probes http://www.inovalley.com/detail.php?item_id=289			R	R	R	R	R		Rubicson
Intertechno (learning mode) http://www.intertechno.at/	RT	RT	RT	RT	RT	RT	RT		AC
Intertechno (with address code wheels)	RT	RT	RT	RT	RT		RT		ARC
JVS screens http://www.screen-discount.nl/	T	T	T	T	RT	RT	RT		BlindsT6
Kambrook RF3672 – http://www.bunnings.com.au/kambrook-4-piece-indoor-powerpoint-kit-with-remote-control_p7030054		T	T				T		Lighting2 Kambrook
Keeloq (unencrypted)			RT		RT	RT	RT		KeeLoq
Kerui security * decoded as X10 in Ext2 and Pro firmware https://www.aliexpress.com/item/433-MHz-Wireless-Door-Windows-Sensors-for-KERUI-Alarm-System-Magnetic-Door-Sensor-Door-Open-reminder/32590916896.html	R	R	R	R*	R*	R*	R*		Lighting4 + X10*
Kimex projection screen https://www.kimexinternational.com/A-9162-ecran-de-projection-electrique-encastrable-3-00-x-1-69m-format-16-9.aspx	RT	RT		RT	RT	RT	RT		BlindsT3
Kingpin KP100 projection screen	T	T	T	T	T	T	T		Lighting4
KlikAanKlikUit (learning mode) http://www.klikaanklikuit.nl/home/	RT	RT	RT	RT	RT	RT	RT		AC
KlikAanKlikUit (with address code wheels)	RT	RT	RT	RT	RT		RT		ARC
La Crosse - TX2, TX3, TX3P, TX4, TX7, TX17, WS2300	R	R	R	R	R	R	R		LaCrosse
Legrand CAD radio			T						Lighting5 LeGrand CAD
Lexibook - SM883	R	R	R	R	R	R	R		Hideki
LightwaveRF - http://www.lightwaverf.co.uk/	RT	RT	RT	RT	RT		RT		AD
Livolo - http://www.livolonederland.nl/ - http://www.livolo-France.com/fr/	T	T	T	T	T		RT		Lighting5 Livolo

Device	Type 1	Type 2	Ext	Ext 2	Pro 1	Pro 2	ProXL 1	Protocol
- http://nl.aliexpress.com/w/wholesale-livolo-touch-switch.html								
Louvolite one touch motorised blinds * = receive only in Type2 used to get the remote ID.	T	RT	T	T	T		RT	BlindsT0
Lucci Air fan http://www.lucciair.com/			T		T	T	T	Fan LucciAir
Lucci Air DC fan For example : Airfusion Climate II 50 DC					T	T	T	Fan LucciAir DC
Lucci Air DCII fan For example : Airfusion Climate II 50 DC					T	T	T	Fan LucciAir DCII
Luxaflex – http://www.luxaflex.se/produkter/luxaflex/rullgardiner/			T	T	T	T	T	RFY
Maplin http://www.maplin.co.uk/p/remote-controlled-mains-socket-set-single-n78ka	T	T	T	T			T	Lighting1 COCO GDR2
Marquant 943134		R					R	X10
Maverick ET-732/733 BBQ/Smoke temperature	R	R	R	R	R		R	Hideki
MCZ pellet stove		T	T				T	Thermostat4
MDremote LED dimmer V106 www.ultraleds.co.uk	T	T	T	T				Lighting5 MDRemote V106
MDremote LED dimmer V107 www.ultraleds.co.uk	T	T	T	T				Lighting5 MDRemote V107
MDremote LED dimmer V108, EKAB-10KRF http://www.ledstripkoning.nl/accessoires/dimmers-wit/draadloze-dimmer-10-knops-rl/	T	T	T	T				Lighting5 MDRemote V108
Meade – TS33F-M, TS34C-M http://www.meade.com/products/weatherstations/sensors.html	R	R	R	R	R	R	R	Hideki
Media Mount Projector screen		T						Lighting4
Meiantech security	RT	RT	RT	RT	RT	RT	RT	Meiantech
Mercury appliance modules http://mercury.avsl.com/product?range=ME5124	T	T	T	T			T	Lighting1 Energenie5
Mertik Maxitrol Fire Place controllers - G6R-H4T1, G6R-H4T5, G6R-H4TD, G6R-H4T16, G6R-H4TB, G6R-H4T21-Z22	RT	RT	RT	RT	RT		RT	Mertik
Mertik Maxitrol Fire Place controller - G6R-H4S	T	T	T	T	T		T	Mertik
Meteoscan W155,W160			R	R	R	R	R	Rubicson
Motorlux blinds motor	T	T		T	T	T	T	BlindsT3
mi.sol WH2 http://www.ebay.com/itm/Transmitter-for-Wireless-Weather-Station-wireless-temperature-sensor-/121664060899	R	R	R	R	R	R	R	FineOffset
NEXA (learning mode) - http://www.nexa.se/	RT	RT	RT	RT	RT	RT	RT	AC
NEXA (with address code wheels)	RT	RT	RT	RT	RT		RT	ARC
NEXA KD101/LM101LC smoke detector	RT	RT	RT	RT	RT	RT	RT	always on
Nexa NBA-001 temperature sensor	R	R	R	R	R	R	R	Hideki
NEXUS - I008T	R	R	R	R	R	R	R	Hideki
Nobily rolladenmotor http://www.nobily.de/rolladenmotor/funk-elektronisch/40mm-achtkantwelle/170/nobily-rolladenmotor-pre4?c=5	T	T	T	T	RT	RT	RT	BlindsT6

Device	Type 1	Type 2	Ext	Ext 2	Pro 1	Pro 2	ProXL 1	Protocol
Oase Inscenio FM Master						T	T	Lighting1 Oase
Opus XT300 /Imagintronix Soil sensor http://www.plantcaretools.com/en/webshop/wireless-moisture-sensor-en-detail http://www.ebay.co.uk/itm/Wireless-Soil-Moisture-Sensor-/251380900939?pt=UK_Home_Garden_Garden_Plants_Fertiliser_CV&hash=item3a8778244b	R	R	R	R	R	R	R	XT300
ORNO	RT	RT	RT	RT	RT	RT	RT	AC
Oregon Scientific / Huger BBQ and weather sensors - AW129, AW131, BTHGN129, BTHR918, BTHR918N, BTHR968, EW109, PCR800, RGR126, RGR682, RGR918, RGR928, RTGN318, RTGR328N, RTGR328N, RTGR368N, RTGR383, RTHN318, STR918, STR928, THGN800, THGN801, THC138, THC238, THC268, THGN122NX, THGN123N, THGN132ES, THGN132N, THGN500, THGR122(N/NX), THGR228(N/NF), THGR238, THGR268, THGR328N, THGR810, THGR918, THGR928, THGRN228NX, THN122N, THN129, THN132N, THR128, THR138, THR288(N/NF), THRN122N, THWR288A, THWR800, UV138, UVN128, UVN800, UVR128, WGR800, WGR918, WTGR800, WTGR800	R	R	R	R	R	R	R	Oregon
Oregon Scientific weighting scales - BWR101, BWR102, GR101 US BWR101, BWR102 in RFXrec	R		R	R			R	Oregon
Oregon MSR939 https://www.redealer.de/multimedia/home-living/wetterstationen/bewegungssensor-msr939/a-200667/			R				R	Oregon
OTIO EHS5050		R					R	RSL
OTIO Lighting	RT	RT		RT	RT		RT	RSL
Outlook Motion Blinds https://www.spotlightstores.com/curtains-blinds/indoor-blinds/roller-blinds/project-outlook-motion-motorised-roller-blind/p/BP80360543		RT			RT	RT	RT	BlindsT4
OWL – CM113	R	R	R				R	Oregon
OWL - CM119, CM160, CM180, CM180i http://www.theowl.com/	R	R	R	R	R	R	R	Oregon
Pearl NC-7159 http://www.pearl.de/a-NC7159-3041.shtml			R	R	R	R	R	Rubicson
Phenix	RT	RT	RT	RT	RT	RT	RT	Lighting4
Philips SBC SP370 series		T					T	Lighting1 Philips SBC
Prego P-8426 http://www.sunmarket.fi/tuote.asp?TID=11990	R	R	R				R	X10
Profile Qnect 423000040,423000042				RT	RT	RT	RT	Lighting4 + AC Pro1 = AC
Profiles PAC-326R Belcanto	RT	RT	RT	RT	RT	RT	RT	ByronSX
Proluxx projection screen	T	T	T		T	T	T	Lighting4
PROmax				T	T	T	T	IT
Proove –TSS320 & TSS330 fridge/freezer thermometer & outdoor sensors 311346,311501	R	R	R	R	R	R	R	FineOffset
Quigg RC DS5 4001-A DE 3726				RT	RT		RT	Lighting4 + AC Pro1 = AC
Quotidom – http://www.quotidom.com/moteur-tubulaire-radio-quotidom-10-ou-20-nm-volet-roulant-ou-store-banne.html (not the Solutio version)	T	T	T	T	RT	RT	RT	BlindsT6

Device	Type 1	Type 2	Ext	Ext 2	Pro 1	Pro 2	ProXL 1		Protocol
RAEX blind motor (YR1326 or YRL2016 controlled)		RT			RT	RT	RT		BlindsT4
RAW data					RT	RT	RT		undec on
Renkforce RF101 smoke detector	RT	RT	RT	RT	RT	RT	RT		always on
Revolt NC5461 http://www.pearl.de/a-NC5462-5452.shtml		R							RSL
RFXSensor	R	R	R	R	R	R	R		X10
RFXMeter	R	R	R	R	R	R	R		X10
RGB LED strip driver dx.com - http://www.dx.com/ order nbr: 130913, (new TRC02 NOT supported) - http://www.dx.com/ order nbr: 67412 * = receive only in Type2 used to get the RGB remote ID.	T	RT	T						AD
RGB432W LED controller	T	T	T						Lighting5 RGB432W
RisingSun	RT	RT	RT	RT			RT		Lighting4
RUBiCSON - stektermometer 48659, 48695 -pool sensor p48019	R		R	R	R	R	R		Rubicson
RohrMotor24 RMF blind motors http://www.rohrmotor24.eu/rohrmotor24	T	T	T	T	RT	RT	RT		BlindsT6
RollerTrol R-series blind motors - http://rollertrol.com/ * = receive only in Type2 used to get the remote ID.	T	RT	T	T	T		RT		BlindsT0
Rollertrol G-series blind motors	T	T	T	T	RT	RT	RT		BlindsT6
Sartano	RT	RT	RT	RT	RT		RT		Lighting4
Screenline motors - http://www.screenline.cz/en/				T			T		BlindsT13
SEAV TXS4				T			T		FAN SEAV TXS4
SelectPlus200689101 & SelectPlus200689103 (Action NL)		RT	RT	RT	RT	RT	RT		ByronSX
Siemens SF01 LF959RA50/LF259RB50/LF959RB50 extractor hood		T					T		Fan SF01
Siemens (UK)	RT	RT	RT	RT	RT		RT		AD
SilverCrest 91089	RT	RT	RT				RT		Lighting4
SilverCrest 60494, 284705				RT	RT		RT		Lighting4 + AC Pro1 = AC
Silverline Premium - http://www.aluparts.nl	T	T	T	T	RT	RT	RT		BlindsT6
Simu / RTS (RFXtrx433E only) - http://www.simu.com/			T	T	T	T	T		RFY
Smartwares radiator valve http://www.homewizard.nl/smartwares-draadloze-radiatorkraan.html			T	T	T	T	T		Radiator1 Smartwares
Smartwares RM174RF				RT					ARC
Somfy / RTS http://www.somfy.co.uk/ To control Somfy Centralis use RFY2 commands.			T	T	T	T	T		RFY
Sonoff RF	RT	RT	RT	RT	RT	RT	RT		Lighting4
Sunperry blind motors		T					T		BlindsT9
Sunvic TLX1206	RT	RT	RT		RT		RT		X10
Sunvic TLX7506	R	R	R		R		R		X10
TechnoLine/Proficell http://www.elv.de/output/controller.aspx?cid=74&detail=10&detail2=27621 - TX95-TH, WS9180-TX104	R		R	R	R	R	R		Rubicson
Teldus 313159 and 313160 https://www.lohelectronics.se/hemautomation/433mhz/sensorer-1110/smart-inne-och-utetermometer-med-hygrometer-10396	R	R	R	R	R	R	R		FineOffset
TFA	R	R	R	R	R	R	R		Hideki

Device	Type 1	Type 2	Ext	Ext 2	Pro 1	Pro 2	ProXL 1		Protocol
- TS15C, TS34C, external temperature sensor 30.3133, anemometer 30.3149, UV sensor, rain sensor 30.3148, pool sensor 30.3160									
TFA - pool sensor 30.3056.10, 30.3216.20				R	R	R	R		Oregon
TFA external temperature sensor 30.3208.02				R	R	R	R		Hideki
UPM/Esic (very short receiving range) WT260, WT260H, WT440H, WT450, WT450H, WDS500, RG700	R				R		R		Hideki
Unitec 48110 EIM 826				RT	RT		RT		Lighting4 + AC Pro1 = AC
Ventus WS155			R	R	R	R	R		Rubicson
Viking - 02035, 02038, 02811	R	R	R	R	R	R	R		FineOffset
Visonic CodeSecure	R	R	R	R	R	R	R		Visonic
Visonic PowerCode	R	R	R	R	RT	RT	R		Visonic
Wave Design extractor hood	T	T	T	T			T		Fan SF01
Waveman	T	T	T	T			T		Lighting1 Waveman
Westinghouse fan 7226640				T			T		Fan
WT0122 pool sensor			R		R	R	R		FineOffset
YOODA blind motors http://www.sukcesgroup.pl	T	T	T	T	RT	RT	RT		BlindsT6
X10 Ninja/Robocam		RT							X10
X10 PC Remote	RT								X10
X10 RTS10 / RFS10	RT	RT	RT	RT	RT	RT	RT		X10
X10 lighting	RT	RT	RT	RT	RT	RT	RT		X10
X10 security	RT	RT	RT	RT	RT	RT	RT		X10
Xdom	RT	RT	RT	RT	RT	RT	RT		X10
Xiron – EN6	R		R	R	RT	R	R		Rubicson

2.3. *undec on*

This parameter is for internal use by RFXCOM only!!!

If new sensor types are released they will most probably not be decoded by the RFXtrx firmware. For this reason we have added the option to enable receive of undecoded messages. This function is only to enable RFXCOM to add this new sensor type in the firmware if possible. If “undec on” is enabled in normal use the application will receive a lot of undecoded messages mostly as a result of RF noise or disturbed RF packets.

Important: For normal use “undec on” should be disabled

2.4. Sensitivity influenced by enabled protocols

All protocols can be enabled in the **Pro firmware** versions; however it is still preferred to enable only the protocols used for receive.

The sensitivity of the receiver part is highly influenced by the number of protocols enabled in Type1, Type2, Ext or Ext2 firmware. Lesser protocols enabled will make the receiver more sensitive for the enabled protocols.

There are a few protocols that will reduce or even eliminate receiving of other protocols if enabled in Type1, Type2, Ext or Ext2 firmware.

For example:

If the AD (LightwaveRF, Siemens) protocol is enabled it can stop receiving of Meiantech / Atlantic, Oregon 3.0, Visonic and Mertik.

All other protocols are disabled if BlindsT0 is enabled in Type1, Type2, Ext or Ext2 firmware.

	X10	ARC	AC	HomeEasy EU	Meiantech/Atlantic	Oregon 1.0	Oregon 2.1	Oregon 3.0 / OWL	ATI	Visonic/Keeloq	Mertik	AD (LWRF)	Hideki/UPM	La Crosse	FS20	ProGuard	BlindsT0	BlindsT1/T2/T3/T4	AE (Blyss)	Rubicson/Alecto	FineOffset/Viking	Lighting4	RSL/Revolt	Byron SX	Imagintronic/Opus	HomeComfort
X10																										
ARC																										
AC																										
HomeEasy EU																										
Meiantech/Atlantic																										
Oregon																										
ATI																										
Visonic/Keeloq																										
Mertik																										
AD (LWRF)																										
Hideki/UPM																										
La Crosse																										
FS20																										
ProGuard																										
BlindsT0																										
BlindsT1/T2/T3																										
AE (Blyss)																										
Rubicson																										
FineOffset/Viking																										
Lighting4																										
RSL																										
Byron SX																										
Imagintronic																										
HomeComfort																										

Green = enabled by default

2.5. RF range reduction

The RF signals operating distance is reduced when the signal has to pass through walls.

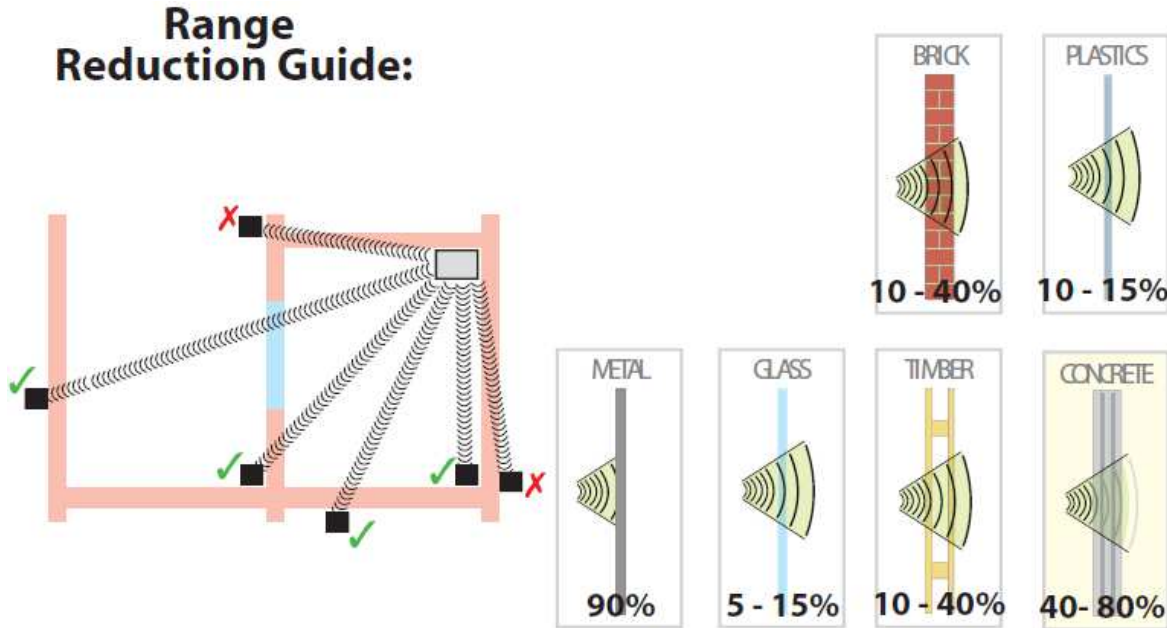

2.6. Home Automation software

For the list of Home Automation software that supports the RFXtrx see the web site www.rfxcom.com

2.7. Dimensions

The dimensions of the RFXtrx/RFXrec are: 83.5 x 42 x 15 mm
Total height from bottom to antenna top is 122mm

The dimensions of the RFXtrx433E are: 83 x 59 x 22 mm
Total height from bottom to antenna top is 130mm

2.8. Electrical

The RFXtrx is powered by the 5 Volt of the USB interface.

Operating current;

Receive mode: 28 mA (0.14Watt)
Transmit mode: 45 mA

The RFXtrx Radiated RF power is 10dBm max.

2.9. Environmental conditions

Normal operating: 15°C to 35°C
Absolute min-max temperature: -10°C to 55°C

3. Install the USB driver

The RFXtrx has the FTDI FT232R USB interface chip installed.

The USB drivers are available at <http://www.ftdichip.com/Drivers/VCP.htm>

4. Run RFXflash on Linux under Mono

Open a Terminal screen in Linux (Ctrl-Alt-T)

Execute once:

Install Mono:

```
[sudo] apt-get install mono-runtime
```

Install VisualBasic support under Mono:

```
[sudo] apt-get install libmono-microsoft-visualbasic8.0-cil
```

If the USB device is created as ttyACMx you will need to create a link between /dev/ttyACMx and a serial port /dev/ttySx.

This is not necessary if the device is created as /dev/ttyUSBx !!

```
[sudo] ln -sf /dev/ttyACM1 /dev/ttyS3
```

Note: sudo must be entered without brackets []. sudo is required if not running as super user.

Launch the RFXflash.exe program.

```
[sudo] mono RFXflash.exe
```

Note: RFXmngn does not operate under mono!

5. RFXmngtr test program

The RFXmngtr program supports decoding of received data and allows you to transmit commands.

After the connection the RFXmngtr program transmits a Reset and Get Status command so that it will know the RFXtrx type and configuration settings:

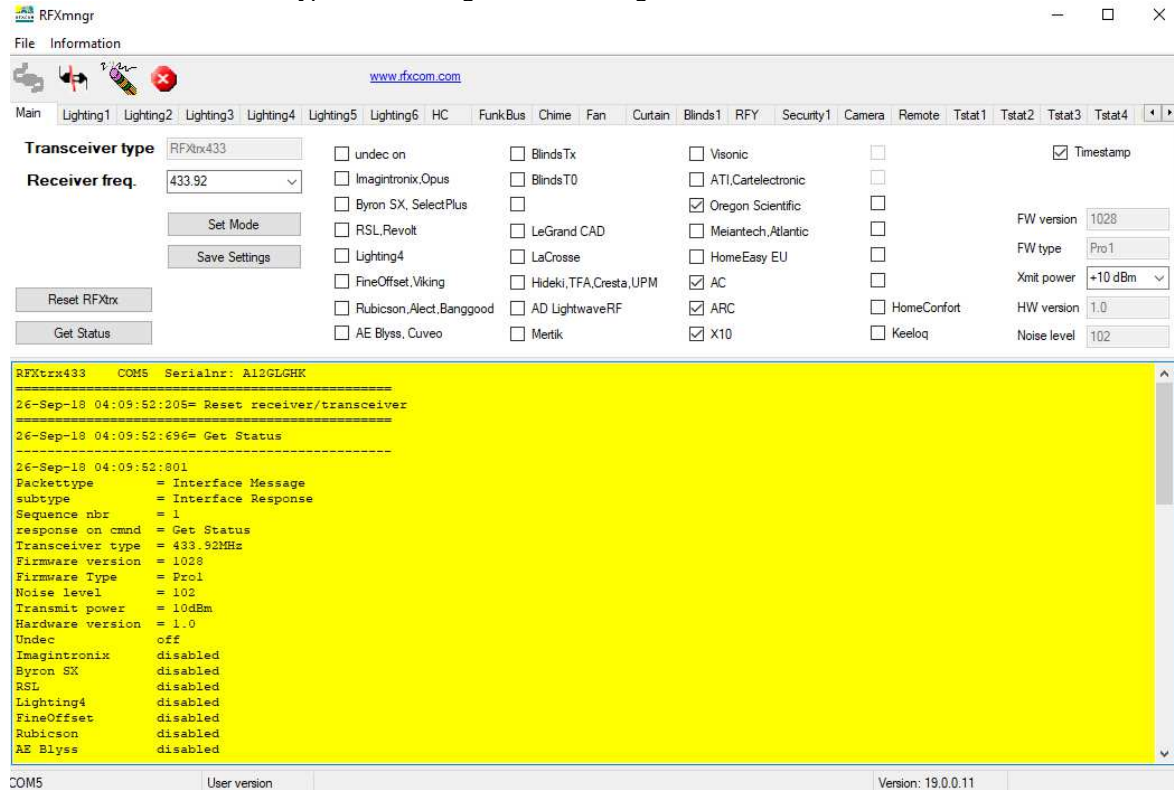

The screenshot shows the RFXmngtr software interface. The main window has a menu bar (File, Information) and a toolbar. Below the toolbar is a navigation bar with tabs for various protocols: Main, Lighting1, Lighting2, Lighting3, Lighting4, Lighting5, Lighting6, HC, FunkBus, Chime, Fan, Curtain, Blinds1, RFY, Security1, Camera, Remote, Tstat1, Tstat2, Tstat3, Tstat4. The main area is divided into two sections. The top section is for configuration, with a 'Transceiver type' dropdown set to 'RFXtrx433' and a 'Receiver freq.' dropdown set to '433.92'. There are 'Set Mode' and 'Save Settings' buttons. Below these are 'Reset RFXtrx' and 'Get Status' buttons. The right side of the configuration area contains a grid of checkboxes for various protocols, with 'Timestamp' checked. The bottom section is a terminal window showing the output of the 'Reset receiver/transceiver' and 'Get Status' commands. The terminal output shows the following details:

```
-----  
RFXtrx433 COM5 Serialnr: A12GLGHK  
-----  
26-Sep-18 04:09:52:205= Reset receiver/transceiver  
-----  
26-Sep-18 04:09:52:696= Get Status  
-----  
26-Sep-18 04:09:52:801  
Packettype = Interface Message  
subtype = Interface Response  
Sequence nbr = 1  
response on cmd = Get Status  
Transceiver type = 433.92MHz  
Firmware version = 1028  
Firmware Type = Pro1  
Noise level = 102  
Transmit power = 10dBm  
Hardware version = 1.0  
Undec = off  
Imagintronic = disabled  
Byron SX = disabled  
RSL = disabled  
Lighting4 = disabled  
FineOffset = disabled  
Rubicon = disabled  
AE Blyss = disabled
```

Transmitter protocols are always enabled but receiver protocols can be disabled. This is very useful because the receiver will become more sensitive when protocols not used are disabled. Select only the protocols to be used for receive, click **Set mode** and click **Save Settings**.

Note that these settings are lost in Type1 and Type2 firmware after a firmware update and need to be set again.

5.1. Receiver

The RF protocols to be received can be configured on the Main tab at **Set Mode**.

Click **Save Settings** to save the selected protocols in non-volatile memory of the RFXtrx. This configuration is now restored every time after a power up.

Note that these settings are lost after a firmware update in Type1 or Type2 firmware and need to be set again.

Note: Protocol enabling is only necessary for receive. Transmit protocols are always enabled.

The received RF data is decoded and displayed in the yellow window.

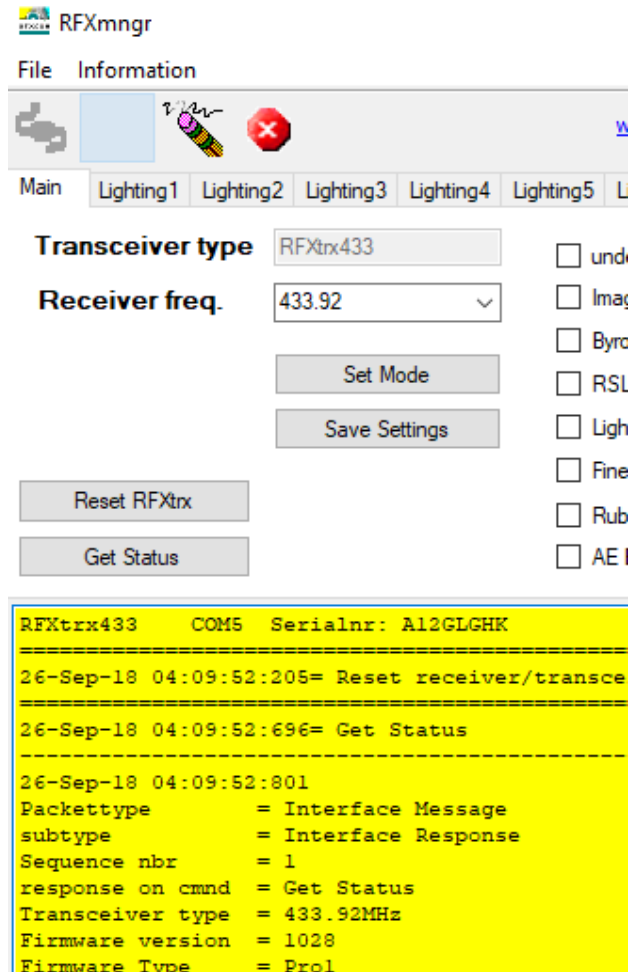

RFXmngn

File Information

Main Lighting1 Lighting2 Lighting3 Lighting4 Lighting5 L

Transceiver type RFXtrx433 und

Receiver freq. 433.92 Imaç

Byrc

RSL

Ligh

Fine

Rub

AE I

Reset RFXtrx

Get Status

```
RFXtrx433 COM5 Serialnr: A12GLGHK
=====
26-Sep-18 04:09:52:205= Reset receiver/transce
=====
26-Sep-18 04:09:52:696= Get Status
-----
26-Sep-18 04:09:52:801
Packettype      = Interface Message
subtype         = Interface Response
Sequence nbr    = 1
response on cmd = Get Status
Transceiver type = 433.92MHz
Firmware version = 1028
Firmware Type   = Prol
```

5.2. Transmitter

The tabs after the Main tab are used to send commands to the transmitter. For example, Lighting1 is used to send X10, ARC and some more.

Note: Protocol enabling is only necessary for receive. Transmit protocols are always enabled.

Select Type to see which protocols are supported on the different tabs.

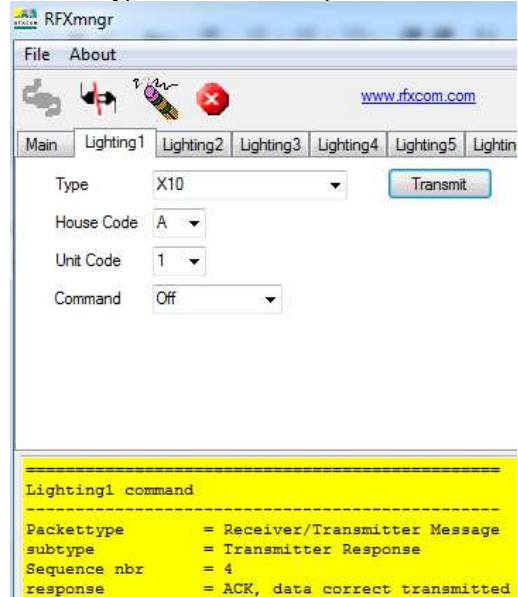

The transmitted commands are displayed in the yellow window including the acknowledge send by the RFXtrx, in the example above "ACK, data correct transmitted".

6. Flash update of the RFXtrx

6.1. Update firmware in the RFXtrx

Firmware is flashed in the RFXtrx using this procedure:

1. Depending on the RFXtrx type download the latest RFXtrx315_yy.hex, RFXrec433_yy.hex, RFXtrx433_yy.hex or RFXtrx433XL_yy.hex firmware file.
2. Connect the RFXtrx to a Windows system or Linux under MONO
3. Stop any program that is connected to the RFXtrx.
4. Start the RFXflash program (version 8.0.0.0 or higher)
5. Select the USB RFXtrx COM port or TCP/IP port and click the CONNECT button, (the red LED on the RFXtrx should switch on now)
6. Load the correct .hex firmware file for your RFXtrx,
7. Click the WRITE button,
8. Click the Normal Execution mode button.

IMPORTANT:

1. Do not interrupt the flash procedure when started.
2. It can happen that the flash procedure ends with a pop-up screen indicating errors. Just disconnect the RFXtrx and start again at step 5 until the flash procedure is finished without errors.

If the red LED does not switch on if you click the CONNECT button:

1. Check if you have selected the correct USB COM port.
2. If you have flashed the RFXtrx before and interrupted the flash procedure it is possible that the RFXtrx does not enter the flash state. Contact support@rfxcom.com for help.

Note: Receiver Settings are lost in Type1 and Type2 firmware after a firmware update and have to be set again.

6.2. Update firmware in the RFXtrx step by step

- Click the Connect to Device button.

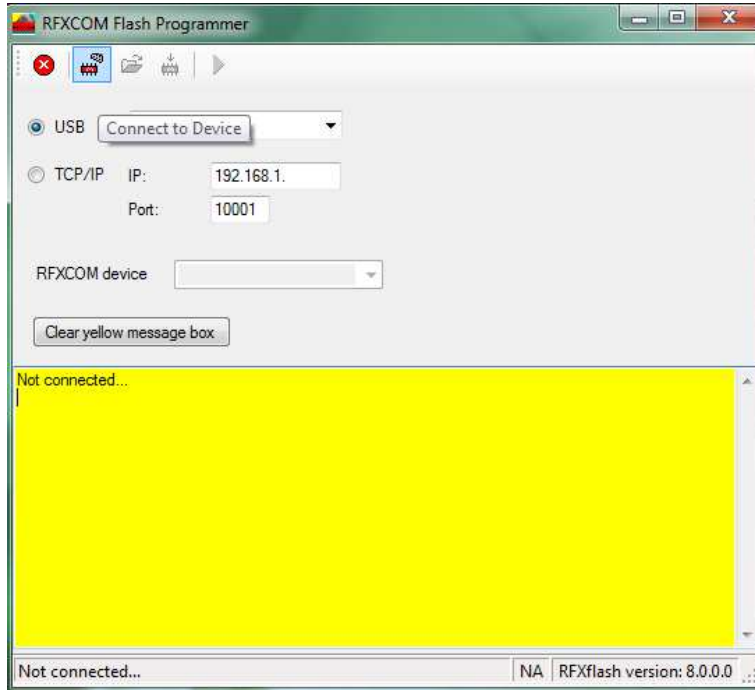

The RFXtrx will automatically switch from normal mode to the bootloader now.

- Click the Open HEX file button and load the RFXtrx $yyy??$ _zz.hex file
Be sure to load the latest firmware file for the RFXtrx.
yyy indicates the RFXtrx frequency, so load the RFXtrx433 for an RFXtrx433!
?? this is XL for the RFXtrxXL versions.
zz indicates the firmware version.

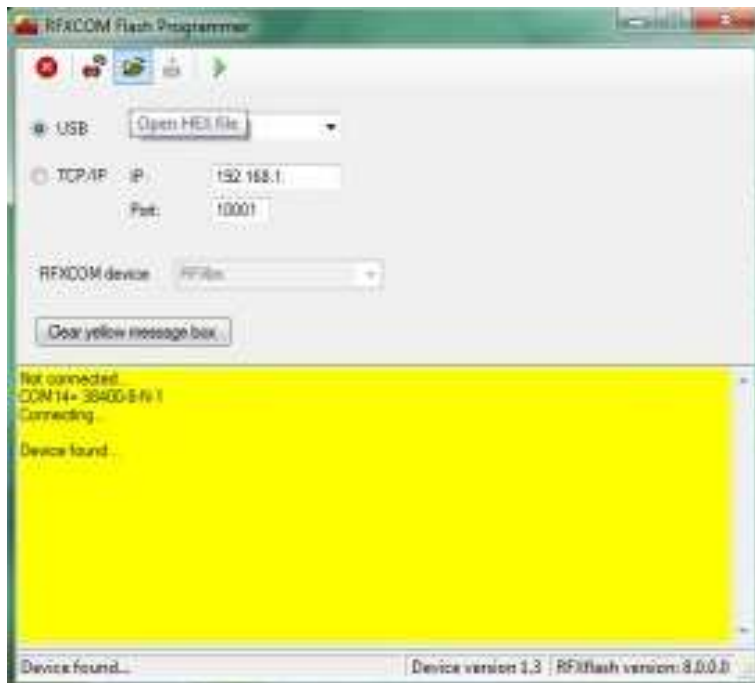

- Click the Write device button and the RFXtrx is flashed.

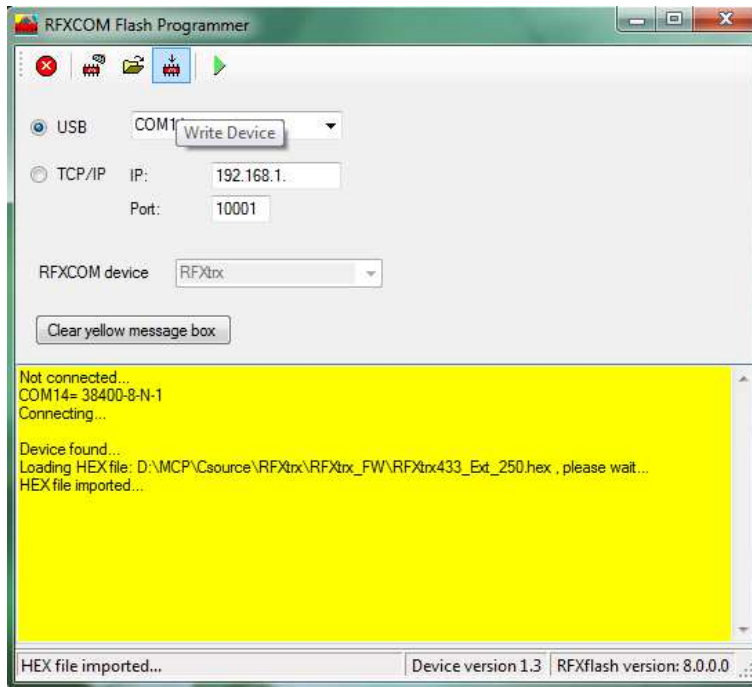

- Click on the Normal Execution Mode button to set the RFXtrx to running mode.

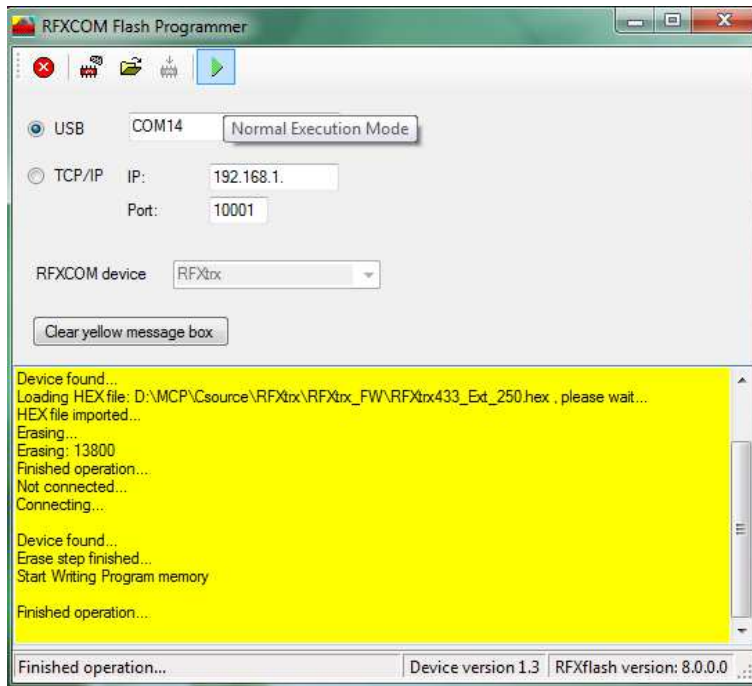

Note: Receiver Settings are lost in Type1 and Type2 firmware after a firmware update and have to be set again.

7. RFXtrx433 special device codes

7.1. Remote commands

7.1.1. X10 RF Remote

Dec	Hex	Button
2	02	0
18	12	8
34	22	4
56	38	Rewind
58	3A	Info
64	40	CHAN+
66	42	2
82	52	Ent
96	60	VOL+
98	62	6
99	63	Stop
100	64	Pause
112	70	Cursor-left
113	71	Cursor-right
114	72	Cursor-up
115	73	Cursor-down
116	74	Cursor-up-left
117	75	Cursor-up-right
118	76	Cursor-down-right
119	77	Cursor-down-left
120	78	left mouse
121	79	left mouse-End
123	7B	Drag
124	7C	right mouse
125	7D	right mouse-End
130	82	1
146	92	9
160	A0	MUTE
162	A2	5
176	B0	Play
182	B6	Menu
184	B8	Fast Forward
186	BA	A+B
192	C0	CHAN-
194	C2	3
201	C9	Exit
209	D1	MP3
210	D2	DVD
211	D3	CD
212	D4	PC / Shift-4
213	D5	Shift-5
214	D6	Shift-Ent
215	D7	Shift-Teletext
216	D8	Text
217	D9	Shift-Text
224	E0	VOL-
226	E2	7
242	F2	Teletext
255	FF	Record

7.1.2. ATI Remote Wonder

Dec	Hex	Button	57	39	Full screen
0	00	A	58	3A	DVD Audio
1	01	B	112	70	Cursor-left
2	02	power	113	71	Cursor-right
3	03	TV	114	72	Cursor-up
4	04	DVD	115	73	Cursor-down
5	05	?	116	74	Cursor-up-left
6	06	Guide	117	75	Cursor-up-right
7	07	Drag	118	76	Cursor-down-right
8	08	VOL+	119	77	Cursor-down-left
9	09	VOL-	120	78	V
10	0A	MUTE	121	79	V-End
11	0B	CHAN+	124	7C	X
12	0C	CHAN-	125	7D	X-End
13	0D	1			
14	0E	2			
15	0F	3			
16	10	4			
17	11	5			
18	12	6			
19	13	7			
20	14	8			
21	15	9			
22	16	txt			
23	17	0			
24	18	snapshot ESC			
25	19	C			
26	1A	^			
27	1B	D			
28	1C	TV/RADIO			
29	1D	<			
30	1E	OK			
31	1F	>			
32	20	<-			
33	21	E			
34	22	v			
35	23	F			
36	24	Rewind			
37	25	Play			
38	26	Fast forward			
39	27	Record			
40	28	Stop			
41	29	Pause			
44	2C	TV			
45	2D	VCR			
46	2E	RADIO			
47	2F	TV Preview			
48	30	Channel list			
49	31	Video Desktop			
50	32	red			
51	33	green			
52	34	yellow			
53	35	blue			
54	36	rename TAB			
55	37	Acquire image			
56	38	edit image			

7.1.3. ATI Remote Wonder Plus

Dec	Hex	Button
0	00	A
1	01	B
2	02	power
3	03	TV
4	04	DVD
5	05	?
6	06	Guide
7	07	Drag
8	08	VOL+
9	09	VOL-
10	0A	MUTE
11	0B	CHAN+
12	0C	CHAN-
13	0D	1
14	0E	2
15	0F	3
16	10	4
17	11	5
18	12	6
19	13	7
20	14	8
21	15	9
22	16	txt
23	17	0
24	18	Open Setup Menu
25	19	C
26	1A	^
27	1B	D
28	1C	FM
29	1D	<
30	1E	OK
31	1F	>
32	20	Max/Restore Window
33	21	E
34	22	v
35	23	F
36	24	Rewind
37	25	Play
38	26	Fast forward
39	27	Record
40	28	Stop
41	29	Pause
42	2A	TV2
43	2B	Clock
44	2C	TV
45	2D	VCR
46	2E	RADIO
47	2F	TV Preview
48	30	Channel list
49	31	Video Desktop
50	32	red
51	33	green
52	34	yellow
53	35	blue
54	36	rename TAB
55	37	Acquire image
56	38	edit image
57	39	Full screen
58	3A	DVD Audio
112	70	Cursor-left
113	71	Cursor-right
114	72	Cursor-up
115	73	Cursor-down
116	74	Cursor-up-left
117	75	Cursor-up-right
118	76	Cursor-down-right
119	77	Cursor-down-left
120	78	Left Mouse Button
121	79	V-End
124	7C	Right Mouse Button
125	7D	X-End

7.1.4. Medion Remote

Dec	Hex	Button	Dec	Hex	Button
0	00	Mute	55	37	Acquire image
1	01	B	56	38	edit image
2	02	power	57	39	Full screen
3	03	TV	58	3A	DVD Audio
4	04	DVD	112	70	Cursor-left
5	05	Photo	113	71	Cursor-right
6	06	Music	114	72	Cursor-up
7	07	Drag	115	73	Cursor-down
8	08	VOL-	116	74	Cursor-up-left
9	09	VOL+	117	75	Cursor-up-right
10	0A	MUTE	118	76	Cursor-down-right
11	0B	CHAN+	119	77	Cursor-down-left
12	0C	CHAN-	120	78	V
13	0D	1	121	79	V-End
14	0E	2	124	7C	X
15	0F	3	125	7D	X-End
16	10	4			
17	11	5			
18	12	6			
19	13	7			
20	14	8			
21	15	9			
22	16	txt			
23	17	0			
24	18	snapshot ESC			
25	19	DVD MENU			
26	1A	^			
27	1B	Setup			
28	1C	TV/RADIO			
29	1D	<			
30	1E	OK			
31	1F	>			
32	20	<-			
33	21	E			
34	22	v			
35	23	F			
36	24	Rewind			
37	25	Play			
38	26	Fast forward			
39	27	Record			
40	28	Stop			
41	29	Pause			
44	2C	TV			
45	2D	VCR			
46	2E	RADIO			
47	2F	TV Preview			
48	30	Channel list			
49	31	Video Desktop			
50	32	red			
51	33	green			
52	34	yellow			
53	35	blue			
54	36	rename TAB			

7.2. Harrison address conversion to switch settings

The address used is converted to the address selected in the Harrison curtain motor using the table below.

switch	1	2	3	4		5	6	7	8
	H	H	H	H		X	X	X	X
A	0	1	1	0	1	0	0	0	0
B	0	1	1	1	2	0	0	0	1
C	0	1	0	0	3	0	0	1	0
D	0	1	0	1	4	0	0	1	1
E	1	0	0	0	5	0	1	0	0
F	1	0	0	1	6	0	1	0	1
G	1	0	1	0	7	0	1	1	0
H	1	0	1	1	8	0	1	1	1
I	1	1	1	0	9	1	0	0	0
J	1	1	1	1	10	1	0	0	1
K	1	1	0	0	11	1	0	1	0
L	1	1	0	1	12	1	0	1	1
M	0	0	0	0	13	1	1	0	0
N	0	0	0	1	14	1	1	0	1
O	0	0	1	0	15	1	1	1	0
P	0	0	1	1	16	1	1	1	1

H H H H = House code
X X X X = device code

Switch position in the motor:

Up = 1

Middle = not used!!!!

Down = 0

Examples:

If you assign the address E7 (1000 0110) to the curtain motor then set the switches to: 1=up, 2=down, 3=down, 4=down, 5=down, 6=up, 7=up, 8=down

If you assign the address A2 (0110 0001) to the curtain motor then set the switches to: 1=down, 2=up, 3=up, 4=down, 5=down, 6=down, 7=down, 8=up

7.3. Flamingo, AB400, IMPULS, Sartano, Brennenstuhl, SilverCrest 91089, Cranenbroek switch settings

Use type ELRO AB400D

Note that the HC (House Code A-P) is the house code used in programs and has no direct relation with the A,B,C,D,E buttons on the remotes!

```

      1 2 3 4  <== switches
HC=====
A   0 0 0 0
B   0 0 0 1
C   0 0 1 0
D   0 0 1 1
E   0 1 0 0
F   0 1 0 1
G   0 1 1 0
H   0 1 1 1
I   1 0 0 0
J   1 0 0 1
K   1 0 1 0
L   1 0 1 1
M   1 1 0 0
N   1 1 0 1
O   1 1 1 0
P   1 1 1 1

      5 A B C D E      5 A B C D E  <== switches
      5 6 7 8 9 10    5 6 7 8 9 10  <== OR switches
DC=====DC=====
1   0 0 0 0 0 0   33  0 0 0 0 0 1
2   0 0 0 1 0 0   34  0 0 0 1 0 1
3   0 0 1 0 0 0   35  0 0 1 0 0 1
4   0 0 1 1 0 0   36  0 0 1 1 0 1
5   0 1 0 0 0 0   37  0 1 0 0 0 1
6   0 1 0 1 0 0   38  0 1 0 1 0 1
7   0 1 1 0 0 0   39  0 1 1 0 0 1
8   0 1 1 1 0 0   40  0 1 1 1 0 1
9   1 0 0 0 0 0   41  1 0 0 0 0 1
10  1 0 0 1 0 0   42  1 0 0 1 0 1
11  1 0 1 0 0 0   43  1 0 1 0 0 1
12  1 0 1 1 0 0   44  1 0 1 1 0 1
13  1 1 0 0 0 0   45  1 1 0 0 0 1
14  1 1 0 1 0 0   46  1 1 0 1 0 1
15  1 1 1 0 0 0   47  1 1 1 0 0 1
16  1 1 1 1 0 0   48  1 1 1 1 0 1
17  0 0 0 0 1 0   49  0 0 0 0 1 1
18  0 0 0 1 1 0   50  0 0 0 1 1 1
19  0 0 1 0 1 0   51  0 0 1 0 1 1
20  0 0 1 1 1 0   52  0 0 1 1 1 1
21  0 1 0 0 1 0   53  0 1 0 0 1 1
22  0 1 0 1 1 0   54  0 1 0 1 1 1
23  0 1 1 0 1 0   55  0 1 1 0 1 1
24  0 1 1 1 1 0   56  0 1 1 1 1 1
25  1 0 0 0 1 0   57  1 0 0 0 1 1
26  1 0 0 1 1 0   58  1 0 0 1 1 1
27  1 0 1 0 1 0   59  1 0 1 0 1 1
28  1 0 1 1 1 0   60  1 0 1 1 1 1
29  1 1 0 0 1 0   61  1 1 0 0 1 1
30  1 1 0 1 1 0   62  1 1 0 1 1 1
31  1 1 1 0 1 0   63  1 1 1 0 1 1
32  1 1 1 1 1 0   64  1 1 1 1 1 1

```

Examples:

```

A1   0 0 0 0 0 0 0 0 0 0
A15  0 0 0 0 1 1 1 0 0 0
N2   1 1 0 1 0 0 0 1 0 0
N11  1 1 0 1 1 0 1 0 0 0

```

0 = switch off
1 = switch on

7.4. Energenie 5-gang 429.950

To know the codes to use open the remote and check the 1 to 5 jumpers connected. If a jumper connection is open it is a 1. If connected it is a 0 (zero)

	1	2	3	4	jumper setting in the remote
HC=====					
A	0	0	0	0	
B	0	0	0	1	
C	0	0	1	0	
D	0	0	1	1	
E	0	1	0	0	
F	0	1	0	1	
G	0	1	1	0	
H	0	1	1	1	
I	1	0	0	0	
J	1	0	0	1	
K	1	0	1	0	
L	1	0	1	1	
M	1	1	0	0	
N	1	1	0	1	
O	1	1	1	0	
P	1	1	1	1	

If jumper 5 is open (1) than add 5 to the remote code.

Examples:

Jumper	1	2	3	4	5	Button Code
1 0 0 0 0	1					I1
1 0 0 0 1	1					I6

7.5. Phenix, IDK YC-4000S switch settings

Use type ELRO AB400D

Note that the HC (House Code A-P) is the house code used in programs and has no direct relation with the A,B,C,D,E buttons on the remotes!

```
HC  switch
    1 2 3 4
=====
```

```
A  0 0 0 0
B  0 0 0 1
C  0 0 1 0
D  0 0 1 1
E  0 1 0 0
F  0 1 0 1
G  0 1 1 0
H  0 1 1 1
I  1 0 0 0
J  1 0 0 1
K  1 0 1 0
L  1 0 1 1
M  1 1 0 0
N  1 1 0 1
O  1 1 1 0
P  1 1 1 1
```

```
DC  switch
    5 A B C D
=====
```

```
1  0 0 0 0 0
2  0 0 0 1 0
3  0 0 1 0 0
4  0 0 1 1 0
5  0 1 0 0 0
6  0 1 0 1 0
7  0 1 1 0 0
8  0 1 1 1 0
9  1 0 0 0 0
10 1 0 0 1 0
11 1 0 1 0 0
12 1 0 1 1 0
13 1 1 0 0 0
14 1 1 0 1 0
15 1 1 1 0 0
16 1 1 1 1 0
17 0 0 0 0 1
18 0 0 0 1 1
19 0 0 1 0 1
20 0 0 1 1 1
21 0 1 0 0 1
22 0 1 0 1 1
23 0 1 1 0 1
24 0 1 1 1 1
25 1 0 0 0 1
26 1 0 0 1 1
27 1 0 1 0 1
28 1 0 1 1 1
29 1 1 0 0 1
30 1 1 0 1 1
31 1 1 1 0 1
32 1 1 1 1 1
```

7.6. HE105 switch settings

Unitnr	HE105 switches
	1 2 3 4 5
0	0 0 0 0 0
1	0 0 0 0 1
2	0 0 0 1 0
3	0 0 0 1 1
4	0 0 1 0 0
5	0 0 1 0 1
6	0 0 1 1 0
7	0 0 1 1 1
8	0 1 0 0 0
9	0 1 0 0 1
10	0 1 0 1 0
11	0 1 0 1 1
12	0 1 1 0 0
13	0 1 1 0 1
14	0 1 1 1 0
15	0 1 1 1 1
16	1 0 0 0 0
17	1 0 0 0 1
18	1 0 0 1 0
19	1 0 0 1 1
20	1 0 1 0 0
21	1 0 1 0 1
22	1 0 1 1 0
23	1 0 1 1 1
24	1 1 0 0 0
25	1 1 0 0 1
26	1 1 0 1 0
27	1 1 0 1 1
28	1 1 1 0 0
29	1 1 1 0 1
30	1 1 1 1 0
31	1 1 1 1 1

7.7. HQ COCO-20

Note that the HC (House Code A-P) is the house code used in programs and has no direct relation with the A,B,C,D,E buttons on the remotes!

```

    6 7 8 9 <== switches in module
HC=====
A   0 0 0 0
B   0 0 0 1
C   0 0 1 0
D   0 0 1 1
E   0 1 0 0
F   0 1 0 1
G   0 1 1 0
H   0 1 1 1
I   1 0 0 0
J   1 0 0 1
K   1 0 1 0
L   1 0 1 1
M   1 1 0 0
N   1 1 0 1
O   1 1 1 0
P   1 1 1 1

    10 1 2 3 4 5          10 1 2 3 4 5 <== switches in module
DC=====DC=====
1   0 0 0 0 0 0    33  1 0 0 0 0 0
2   0 0 0 0 0 1    34  1 0 0 0 0 1
3   0 0 0 0 1 0    35  1 0 0 0 1 0
4   0 0 0 0 1 1    36  1 0 0 0 1 1
5   0 0 0 1 0 0    37  1 0 0 1 0 0
6   0 0 0 1 0 1    38  1 0 0 1 0 1
7   0 0 0 1 1 0    39  1 0 0 1 1 0
8   0 0 0 1 1 1    40  1 0 0 1 1 1
9   0 0 1 0 0 0    41  1 0 1 0 0 0
10  0 0 1 0 0 1    42  1 0 1 0 0 1
11  0 0 1 0 1 0    43  1 0 1 0 1 0
12  0 0 1 0 1 1    44  1 0 1 0 1 1
13  0 0 1 1 0 0    45  1 0 1 1 0 0
14  0 0 1 1 0 1    46  1 0 1 1 0 1
15  0 0 1 1 1 0    47  1 0 1 1 1 0
16  0 0 1 1 1 1    48  1 0 1 1 1 1
17  0 1 0 0 0 0    49  1 1 0 0 0 0
18  0 1 0 0 0 1    50  1 1 0 0 0 1
19  0 1 0 0 1 0    51  1 1 0 0 1 0
20  0 1 0 0 1 1    52  1 1 0 0 1 1
21  0 1 0 1 0 0    53  1 1 0 1 0 0
22  0 1 0 1 0 1    54  1 1 0 1 0 1
23  0 1 0 1 1 0    55  1 1 0 1 1 0
24  0 1 0 1 1 1    56  1 1 0 1 1 1
25  0 1 1 0 0 0    57  1 1 1 0 0 0
26  0 1 1 0 0 1    58  1 1 1 0 0 1
27  0 1 1 0 1 0    59  1 1 1 0 1 0
28  0 1 1 0 1 1    60  1 1 1 0 1 1
29  0 1 1 1 0 0    61  1 1 1 1 0 0
30  0 1 1 1 0 1    62  1 1 1 1 0 1
31  0 1 1 1 1 0    63  1 1 1 1 1 0
32  0 1 1 1 1 1    64  1 1 1 1 1 1

```

Examples:

Switch 6 7 8 9 0 1 2 3 4 5

```

=====
A1   0000000000
A15  0000111000
N2   1101000100
N11  1101101000

```

0 = switch off

1 = switch on

7.8. MDREMOTE V106, V107

This MDREMOTE has been tested.

<http://www.ultraleds.co.uk/mini-dimmer-with-rf-remote-control-12-or-24v-dc-12a-maximum.html>

The RFXtrx433 can only transmit MDREMOTE commands.

Procedure to find the ID of the MDREMOTE: In RFXmngn enable the X10 protocol and enable "Undec on". Press a button on the MDREMOTE remote.

The undecoded message contains the ID in the 2nd and 3rd byte, for example:

UNDECODED NEC:20AF6801D1

The 2 bytes after 20 is the MDREMOTE ID, in this example AF 68

7.9. MDREMOTE V108, EKAB-10KRF

This MDREMOTE has been tested.

- <http://www.ledstripkoning.nl/accessoires/dimmers-wit/draadloze-dimmer-10-knops-rf/>

Procedure to find the ID of the MDREMOTE: In RFXmngn enable the Lighting4 protocol and enable "Undec on". Press a button on the MDREMOTE remote.

The undecoded message contains the ID in the 2nd and 3rd byte, for example:

UNDECODED ARC:201A0703FCFC

The 2 bytes after 20 is the MDREMOTE ID, in this example 1A 07

7.10. Aoke relay

The Aoke 12V DC - 315MHz or 433.92MHz 1 channel relay is available at www.aliexpress.com store No.110758. Indicate clearly the required frequency when ordering!

The 1 channel learning relays can be used, see the picture below.

For example, for 1 relay:

http://www.aliexpress.com/store/product/DC12V-1CH-wireless-switch-remote-control-system-remote-control-switch-for-guard-door-window-curtain/110758_936534863.html

or for 6 relays:

http://www.aliexpress.com/store/product/ak-DC12V-1CH-RF-rocker-switch-livolo-switch-system-in-china-i-12a-108d-smart-house/110758_1007306574.html



The jumper next to the learning button defines to operating mode:
Open = momentary
1-2 = toggle mode
2-3 = on/off mode (to be used with the RFXtrx)

7.11. SEAV TXS4

The ID can be found using RFXmngnr and enable only ByronSX and undec on.

Or calculate the ID:

A SW1 switch on = 1

```
|-----SW1-----|
 1 2 3   4 5 6 7   8 9 10
0 x x x | x x x x | x x x 0 | 0 1 0 1
```

For example SW1 = on off on off on off on off on off

The ID will become:

```
|-----SW1-----|
 1 2 3   4 5 6 7   8 9 10
0 1 0 1 | 0 1 0 1 | 0 1 0 0 0 | 0 1 0 1 this is hex: 5 5 4 5
```

7.12. How to find the dx.com RGB LED strip driver ID

Valid for the TRC02 remote with 2 batteries.

Flash the RFXtrx433 with Type2 firmware to be able to receive the remote ID in RFXmngnr. In RFXmngnr enable only the LightwaveRF (AD) protocol.

```
-----
Packettype = Lighting5
subtype    = RGB TRC02
Sequence nbr = 5
ID       = FCC48B
Command    = On
Signal level = 8
The ID is: FC C4 8B
```

If necessary flash the RFXtrx433 back to Type1 or ext if Type2 does not support devices you need. (See chapter 2.2)

7.13. How to find the dx.com RGB LED strip driver ID (rev. 2)

Valid for the TRC02 remote with 3 batteries and ebay.com 191481664563.

In RFXmngnr enable only the Lighting4 protocol.

```
-----
Packettype = Lighting4
subtype    = PT2262
Sequence nbr = 29
Code       = 161C84
The ID is: 16 1C
```

7.14. How to find the Eurodomest ID

You can assign a random ID to the Eurodomest. If you want to use the same ID as the remote you can find the ID of the remote using RFXmngnr.

Start RFXmngnr and enable only the Lighting4 protocol.

Press a button on the remote and you will receive a message like:

```
-----
Packettype = Lighting4
subtype    = PT2262
Sequence nbr = 12
Code       = 6DFE0F
The ID is: 6 DF E0
```

Note: Eurodomest can also be controlled using ARC.

7.15. How to find the Screenline ID

You can assign a random ID to the Screenline. If you want to use the same ID as the remote you can find the ID of the remote using RFXmngr.

Start RFXmngr and enable only the Lighting4 protocol and undec on.

Press a button on the remote and you will receive a message like:

```
-----  
Packettype = UNDECODED RF Message  
UNDECODED ARC:4000F7BD1D2AF04B7
```

The ID starts at the 7th character, in this example the ID = **7B D1**

7.16. How to find the Avantek remote ID

You can find the ID of the remote using RFXmngr.

Start RFXmngr and enable only the Lighting4 protocol.

Press a button on the remote and you will receive a message like:

```
Packettype      = Lighting4  
subtype         = PT2262  
Sequence nbr   = 3  
Code            = 122336 decimal:1188662  
S1- S24        = 0001 0010 0010 0011 0011 0110  
Pulse           = 280 usec  
Signal level   = 7 -64dBm
```

The ID to be used is **1 22 33**

8. Blyss commands

Some Blyss devices, like the Blyss motors, require a special command sequence number. To simplify it; 0,1,2,3,4,0,1,...

This sequence number is normally created by the Blyss remote but now also by the RFXtrx433.

If you use a Blyss remote and the application (Domoticz, DomotiGa, Homeseer...) does not sync with the received Blyss command you will see that you need to send multiple commands with the RFXtrx433 before the Blyss device will respond.

For example,

The Blyss remote transmits with the sequence numbers 0,1,2

If the RFXtrx433 transmits now with sequence number 0 it will not be seen by the Blyss device as a valid command and at the time the RFXtrx433 transmits the commands 1,2,3 the command will be detected as valid when it receives the command with sequence number 3.

The same is true for the remote. If you transmit commands with the RFXtrx433 and after that with a Blyss remote you need to transmit several commands with the remote before the Blyss device responds.

I guess the same behaviour will show if you use multiple Blyss remotes.

9. Somfy RTS

Somfy RTS* devices can only be controlled by the RFXtrx433E. (not with the RFXtrx433)
The RFXtrx433E version is an RFXtrx433 with additional hardware to enable the RFY protocol used to control Somfy RTS.

The 433.42MHz transmitter in the RFXtrx433E is used for a reliable control of the Somfy RTS devices over a large distance and through walls.

The RFXtrx433E 433.92MHz transmitter is used to control all other devices.

To pair the Somfy RTS device:

- Select a unique ID and unitcode for the RFXCOM RFY device.
- Disconnect power from all Somfy RTS devices except the device to pair.
- Press the Program button > 2 seconds on the original Somfy remote until the Somfy device responds.
- Transmit a Program command with the RFXtrx433E. The Somfy RTS device should respond indicating the pair command was successful.

The RFXCOM RFY remote is registered in the RFXtrx433E by sending a Program command.

Up to 40 RFXCOM RFY remotes can be registered in the RFXtrx433E.

Remotes can be erased from the RFXtrx433E using the RFXmng program.

The Somfy RTS device can be controlled by any application as long as the same ID and Unit Code are used.

For example if the RTS device is paired using RFXmng with ID=1 02 03 and Unit Code 1, the RTS device can be controlled with Homeseer using the same ID and unit code.

Usage:

To control Somfy Centralis modules use the RFY2 = > 2 seconds commands.

Somfy Tilt motors can be configured in 2 modes, US or European.

To toggle between modes, press the Reset/ Prog button 2 s. Repeat until the LED, according to the desired configuration, lights up. Store by pressing 2 s.

To control Venetian Blinds in US mode:

- up/down (transmit < 0.5 seconds): open or close
- up/down (transmit > 2seconds): change angle

To control Venetian Blinds in Europe mode:

- up/down (transmit < 0.5 seconds): change angle
- up/down (transmit > 2seconds): open or close

Somfy RTS motors have a limited number of memory locations for the remotes. Some have a max of 10 remotes. If you try to pair the 11th remote (can be a RFXtrx433E ID-unit) the motor reacts as if the pairing was successful but there is no response on an up/down command.

To solve this, reset the motor to remove all remotes.

* Somfy RTS are registered trademarks of Somfy System, Inc.

10. BlindsT6

To add a RFXtrx433(E) BlindsT6 device to the blinds motor:

1. press the "program" button twice on the original remote ==> 2 beeps
2. transmit the "confirm" command with the RFXtrx433(E) ==> 5 beeps

10.1. Dooya DT52E, DT82TV, DT82TN

- Select a random ID different from all zeroes and a unit code 1 to 15
- Press the program button on the motor until the LED lights up
- Transmit a Confirm command
- The LED on the motor starts blinking
- Transmit again a Confirm command
- The LED on the motor blinks 5 times
- The motor can be controlled now by the RFXtrx433(E)

11. Lucci Air fans

Select the ID for switch settings:

ID	Remote switches
	1 2 3 4
0	0 0 0 0
1	0 0 0 1
2	0 0 1 0
3	0 0 1 1
4	0 1 0 0
5	0 1 0 1
6	0 1 1 0
7	0 1 1 1
8	1 0 0 0
9	1 0 0 1
A	1 0 1 0
B	1 0 1 1
C	1 1 0 0
D	1 1 0 1
E	1 1 1 0
F	1 1 1 1

For LucciAir AC fan: 0 = ON

For LucciAir DC fan: 1 = ON

12. Transmit undecoded ARC commands.

Plug-in modules or other equipment with a PT2262 can be controlled using Lighting4. There are a lot of brands using the PT2262 and some of them use the same timing (350) as used by the ARC devices but a different protocol definition.

Messages will be received as undecoded ARC messages if the protocol definition does not match the definition of the ARC protocol. Remote commands are received as ARC commands with a wrong house and device code and/or command code or as undecoded ARC messages if "undec on" is enabled. Decoding of these remotes is therefore not possible because they overlap the ARC protocol partly.

But transmitting these commands is possible using the Lighting4 command.

So if we receive this command UNDECODED ARC:18014403:
(18 is not used)

hex to binary table

```
0=0 0 0 0
1=0 0 0 1
2=0 0 1 0
3=0 0 1 1
4=0 1 0 0
5=0 1 0 1
6=0 1 1 0
7=0 1 1 1
8=1 0 0 0
9=1 0 0 1
A=1 0 1 0
B=1 0 1 1
C=1 1 0 0
D=1 1 0 1
E=1 1 1 0
F=1 1 1 1
```

0 1 4 4 0 3 = selection box 0000 0001 0100 0100 0000 0011

Not selected = 0, box selected = 1

And the Lighting4 command contains the same "undec code" 01 44 03:

Lighting4 command:09 13 00 04 **01 44 03** 01 5E 00

pulse timing is 350 = hex 015E

Another example:

For this command UNDECODED ARC:18014430 set on the Lighting4 tab in RFXmngnr selection box 1 to 24 to 0 1 4 4 3 0 = 0000 0001 0100 0100 0011 0000

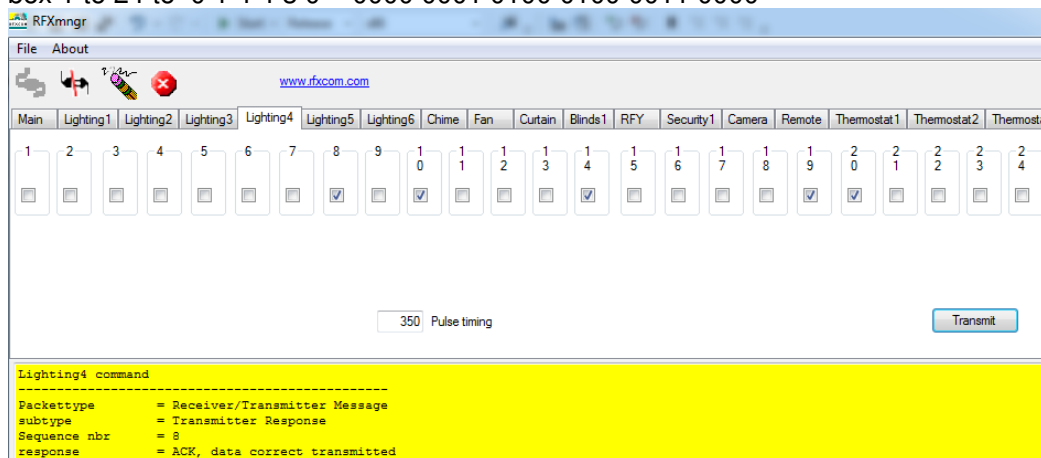

13. MCZ pellet stove.

In the Type2 firmware zip file which is available on the downloads page you will find a special firmware RFXtrxMCZ.hex that enables you to know the ID of the your MCZ remote.

Flash the RFXtrxMCZ.hex firmware in your RFXtrx433(E) and start RFXmngr.
Transmit a command with the MCZ remote and you will receive the information.

The ID in this example is 81 3F 22

```
Packettype = Thermostat4
subtype    = MCZ pellet stove 2 fans model
Sequence nbr = 0
ID         = 0x813F22 decimal:8470306
Beep       = Yes
Fan1 speed = 1
Fan2 speed = 7
Flame power = 1
Command    = Off
Signal level = 6 -72dBm
```

Flash now Type2 or Ext firmware in your RFXtrx433(E) and you can control your MCZ stove using the received ID.

Important: remove the batteries from the original remote before you start using the RFXtrx433 to control the MCZ stove!

14. Lighting4 devices

14.1. Proluxx projection screen

Use Lighting4 with a pulse timing of 360

UP	1110 1101 0101 1001 0101 0010	ED 59 52
STOP	1110 1101 0101 1001 0101 1000	ED 59 58
DOWN	1110 1101 0101 1001 0101 0100	ED 59 54
RESET	1110 1101 0101 1001 0101 0001	ED 59 51

14.2. Kingpin (KP100) projection screen

Use Lighting4 with a pulse timing of 1040

UP	1110 0001 0100 0010 0010 0010	E1 42 22
STOP	1110 0001 0100 0010 0010 0100	E1 42 24
DOWN	1110 0001 0100 0010 0010 1000	E1 42 28
PROGRAM	1110 0001 0100 0010 0010 0001	E1 42 21

14.3. Mercury remote control mains sockets

<http://mercury.avsl.com/product?range=ME5124>

Use Lighting4 with a pulse timing of 188

1 OFF	01000100010101010011	1100
1 ON	01000100010101010011	0011
2 OFF	01000100010101011100	1100
2 ON	01000100010101011100	0011
3 OFF	01000100010101110000	1100
3 ON	01000100010101110000	0011
4 OFF	01000100010111010000	1100
4 ON	01000100010111010000	0011
5 OFF	01000100011101010000	1100
5 ON	01000100011101010000	0011

14.4. Conrad 034911 sockets

<http://www.conrad.nl/ce/nl/product/034911/Draadloze-schakelaarset-5-delig>

Use Lighting4 with a pulse timing of 425

Off = last 2 digits: 00

ON = last 2 digits: 01

Group	Unit																				
I	1 OFF	00 01 01 01	00 01 01 01 01 01 01 00																		
II	1 OFF	01 00 01 01	00 01 01 01 01 01 01 00																		
III	1 OFF	01 01 00 01	00 01 01 01 01 01 01 00																		
IV	1 OFF	01 01 01 00	00 01 01 01 01 01 01 00																		
I	1 OFF	00 01 01 01	00 01 01 01 01 01 01 00																		
I	2 OFF	00 01 01 01	01 00 01 01 01 01 01 00																		
I	3 OFF	00 01 01 01	01 01 00 01 01 01 01 00																		
I	4 OFF	00 01 01 01	01 01 01 00 01 01 01 00																		
I	1 OFF	00 01 01 01	00 01 01 01 01 01 01 00																		00
I	1 ON	00 01 01 01	00 01 01 01 01 01 01 01																		01

14.5. Sonoff

All Sonoff 433MHz RF receiver devices can be controlled by the RFXtrx433 and RFXtrx433E using Lighting4 with a pulse timing of 370usec.

The 4 button Sonoff Lighting4 remote code:

The last digit indicates the button:

A	0001	hex 1
B	0010	hex 2
C	0100	hex 4
D	1000	hex 8

The first 5 digits are the ID. Here an example of ID=D216B button=A

Packettype = Lighting4

subtype = PT2262

Sequence nbr = 1

Code = D216B1 decimal:13768369

S1- S24 = 1101 0010 0001 0110 1011 0001

Pulse = 370 usec

Signal level = 8 -56dBm

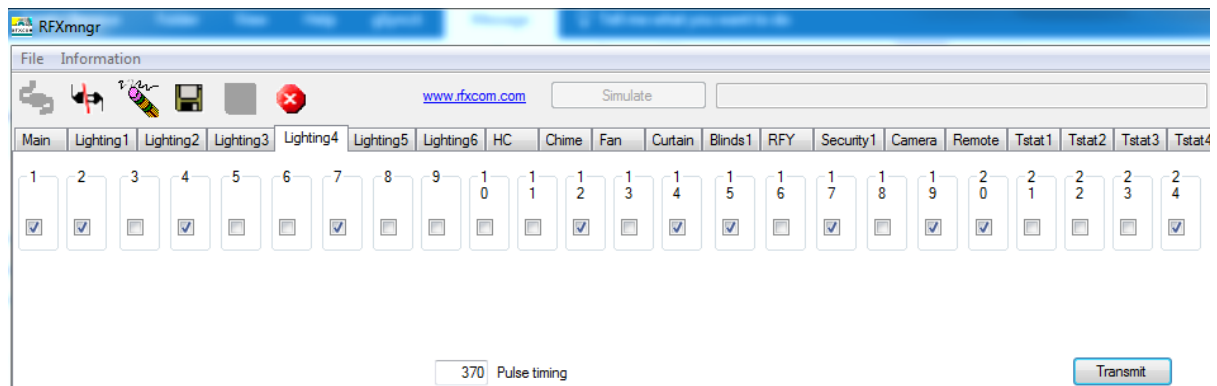

The Lighting4 commands can be used for example to control the 4 relays in a Sonoff 4CH Pro https://www.banggood.com/SONOFF-4CH-Pro-10A-2200W-2_4Ghz-433MHz-RF-InchingSelf-LockingInterlock-Smart-Home-p-1153324.html

14.6. PT2262 and EV1527 oscillator resistors accepted

For the PT2262 use a 3M3 oscillator resistor

For the EV1527 a 220K, 270K or 390K oscillator resistor can be used.

15. Receive and Transmit RAW data

The Pro firmware can receive and transmit RAW data. This can be used to replay received data received from a remote. Note that this can only be used for a protocol with fixed code and rolling code cannot be used.

It is unknown if and how this is implemented in Home Automation applications!

Here an example of a packet received from an ARC remote in RFXmngr:

```
RAW Packet:
687F000001010804720132046701340467041401BB01300474013104680131046E0131046D0131047001330470012D046B0
133046C013004720132046E013104690132046A0133046D0138046C0130046A041401B901310471041701B70133046A0133
046F012E0000
Packettype = RAW Packet
Packet Length = 104
subtype = RAW packet
Sequence nbr = 0
Repeat = 1
Nbr of pulses = 25
264 1138 306 1127 308 1127 1044 443 304 1140 305 1128 305 1134 305 1133 305 1136
307 1136 301 1131 307 1132 304 1138 306 1134 305 1129 306 1130 307 1133 312 1132
304 1130 1044 441 305 1137 1047 439 307 1130 307 1135 302 0
```

The last value of zero indicates a gap timeout and the real gap is greater than 8000. To replay this packet replace the last zero with a value greater than 8000.

To replay this in RFXmngr, create a text file with the content below and send it on the RAW transmit tab.

The first value is 0 which indicates it is a single packet

The next value (7 in this example) is the repeat count.

Do not set the repeat count too high to lower the risk to disturb other RF transmissions.

```
0
7
264
1138
306
1127
308
1127
1044
443
304
1140
305
1128
305
1134
305
1133
305
1136
```

the next values

```
307
1135
302
10000
```

If you receive multiple RAW packet with more than 62 pulses, try to find the gap. This is normally a higher value and smaller than 8000. Here an example with a gap value of 6600 and the next 6596.

```
RAW Packet:
FC7F00000001190491012C0491012A0492012A0490012A049201270493012801B7040601BC03FF01B903FF048F012C04930
1270493012801B9040001BB03FF01BC040101BB03FF01BB040019C8013C049301280491012A049201290492012704940127
0494012701BE040201BA03FF01BD03FE0492012A049201290492012901BB03FF01BC03FF01BB040401BB03FF01BD040019C
401400490012B048F012D048F012A04950127049301270494012701BC040201BD03FF01BA03FF0493012804920128049501
2601BB040001BC040001B8040601B903FF01BC03FF19C801400492012A049301280492012A0495012704940128049501280
1BA040501BD
Packettype = RAW Packet
Packet Length = 252
subtype = RAW packet
Sequence nbr = 0
Repeat = 0
Nbr of pulses = 62
281 1169 300 1169 298 1170 298 1168 298 1170 295 1171 296 439 1030 444 1023 441
1023 1167 300 1171 295 1171 296 441 1024 443 1023 444 1025 443 1023 443 1024 6600
316 1171 296 1169 298 1170 297 1170 295 1172 295 1172 295 446 1026 442 1023 445
1022 1170 298 1170 297 1170 297 443 1023 444 1023 443 1028 443 1023 445 1024 6596
320 1168 299 1167 301 1167 298 1173 295 1171 295 1172 295 444 1026 445 1023 442
1023 1171 296 1170 296 1173 294 443 1024 444 1024 440 1030 441 1023 444 1023 6600
320 1170 298 1171 296 1170 298 1173 295 1172 296 1173 296 442 1029 445
```

Create a text file to control this device in RFXmng:

```
0
7
281
1169
300
1169
298
1170
298
1168
298
1170
295
1171
296
439
1030
444
1023
441
1023
1167
300
1171
295
1171
296
441
1024
443
1023
444
1025
443
1023
443
1024
6600
```

16. RFXtrx433XL - P1 smart meter connection

The RFXtrx433XL can be connected to the Dutch P1 smart meter.

The smart meter connector type is RJ12. The Metering System holds a female connector, the customer can plug in a standard RJ12 or RJ11 plug.

RJ12 is a 6P6C (6 positions, 6 contacts)

RJ11 is a 6P4C (6 positions, 4 contacts) This one can be used to connect the RFXtrx433XL.

Pin #	Signal name	Description
1	+ 5V power	Power supply (not used by the RFXtrx433XL)
2	RTS	
3	GND	Data GND
4	NC	Not connected
5	RxD	Data output to the RFXtrx433XL
6	GND power	Power GND (not used by the RFXtrx433XL)

RJ12 and RJ11 connections:

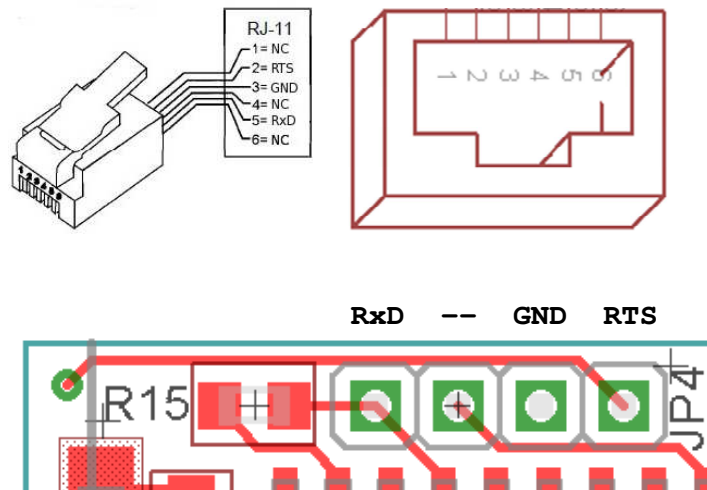

Select the correct baud rate for your smart meter:

Meter Brand	Baud rate	DMSR version
Kamstrup	9600	2.2
Iskra	9600	2.2
Kaifa	115200	4.0
Landis + Gyr	115200	4.0

The connection can be tested in RFXmngn.

Select: Enabled, 9600 or 115200, No, 8, 1, Inverse and click Set Async port.

Important: the P1 connection must be present!

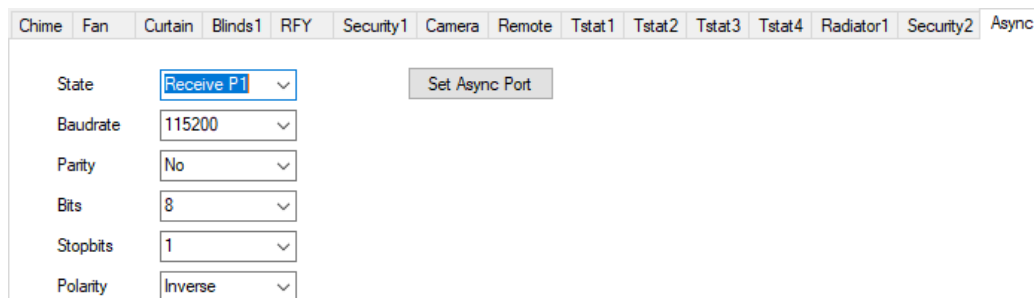

17. FAQ

17.1. Receive has stopped suddenly but transmit works.

Most probably a sensor is transmitting constantly. This could be for example an X10 MS13 motion sensor or weather sensor with almost empty battery. Or an outside weather sensor filled with water. Or a remote with a button pressed.

Test the RFXtrx with a remote or sensor on another location (> 1km away) using RFXmngn on a Windows system or laptop.

17.2. Can I increase the receive/transmit range of the RFXtrx?

First check chapter 2.5 for the best place for the RFXtrx antenna.

The switch board is not the best place for the RFXtrx because of all metal objects that will absorb or reflect the RF signals.

It is also advised to place the RFXtrx far away from PC's, routers, Raspberry PI ... because of the RF noise those products produce and this will reduce the receive range very much.

You can connect another 50ohm 70cm/433MHz antenna with more gain.

For example <http://www.ebay.com/itm/290979680030>

Install this antenna on a metal plate of at least 30 cm for optimum result.

17.3. The RFXtrx USB connection disconnects sometimes.

This happens mostly on Raspberry PI with a low quality power supply. Solution is to use a powered USB hub with a good quality power supply.

It can also happen if the USB cable is running along a power cable or a power device is switched on that produces a high power spike like a fluorescent tube. Solution is to separate the USB cable from all other cables and/or use a powered USB hub with a good quality power supply.

17.4. I have a 433.92MHz sensor/remote but this device is not received.

Besides the frequency the used protocol and modulation type is also important.

See chapter 2 for the list of supported devices.

17.5. The wall plug is switched by the remote, the remote is received but the RFXtrx does not switch the module.

The remote transmits several protocols. The protocol used by the wall plug is not received by the RFXtrx but some other protocols are received.

Solution:

For the HomeEasy EU- HE8xx series: reset the module to remove all paired remotes and pair the module with the RFXtrx433E and one of remote codes that is received.

For IT modules FA500/PROmax: Pair the RFXtrx433E with the module using an IT device and select a random ID. The received remote code can be used to know if the module is switched by the remote.

18. EC Declaration of Conformity

EC Declaration of Conformity

RFXCOM declares that the product:

RFXtrx

Brand: RFXCOM Type: RFXtrx433, RFXtrx433E, RFXtrx433XL

conforms with the essential requirements and other relevant provisions of the following directives and complies with the following standards applied:

R&TTE Directive 99/5/EC	EN 300 220-1 V2.4.1 (2012-05)
	EN 300 220-2 V2.4.1 (2012-05)

Low-voltage Directive 2006/95/EC	IEC 60950-1 (2005-12)
----------------------------------	-----------------------

EMC Directive 2004/108/EC	EN 301 489-1 V1.9.2 (2011-09)
	EN 301 489-3 V1.4.1 (2002-08)

19. Warning:

- RF signals are possible disturbed, and it has not been justified for this equipment at uses in circumstances where life-threatening or dangerous situations are possible.
- RFXCOM HARDWARE AND SOFTWARE IS NOT INTENDED FOR USE IN THE OPERATION OF NUCLEAR FACILITIES, AIRCRAFT NAVIGATION OR COMMUNICATION SYSTEMS, AIR TRAFFIC CONTROL SYSTEMS, LIFE SUPPORT MACHINES OR OTHER EQUIPMENT IN WHICH THE FAILURE OF THE SOFTWARE COULD LEAD TO DEATH, PERSONAL INJURY, OR SEVERE PHYSICAL OR ENVIRONMENTAL DAMAGE.

20. License

- You are allowed to use RFXCOM software, protocols and Written Materials with RFXCOM hardware only.
- All copyright and other proprietary notices associated with RFXCOM software, protocols and Written Materials shall be visible to all users.
- You may not sell, distribute, loan, rent, lease, license, sublicense or otherwise assign or transfer RFXCOM software or RFXtrx protocols or Written Materials unless expressly authorized in writing by RFXCOM.
- You may not use any RFXCOM device, software or protocol as part of an exclusive or patented product without the express prior written permission of RFXCOM.
- You may not alter, modify, adapt or create derivative works based on any part of RFXCOM software or protocols or Written Materials in any way, including translating, reverse engineering, disassembling or decompiling the software.

21. Copyright notice

- All RFXCOM hardware, software, protocols and Written Materials are protected by copyright laws, and may not be reproduced, republished, distributed, transmitted, displayed, broadcast or otherwise exploited in any manner without the express prior written permission of RFXCOM.
- Netherlands Copyright and international treaty provisions protect the SOFTWARE, HARDWARE, RFXtrx protocols and Written Materials and shall be subject to the exclusive jurisdiction of the Netherlands Courts
- RFXCOM reserves all rights not expressly granted herein.

22. Revision history

- Version 0.0 – August 18, 2011
Initial version.
- Version 1.0 – October 30, 2011
RFXflash under Mono added.
- Version 2.0 – December 30, 2011
Updated for the production version with FTDI USB chip
- Version 2.1 – January 18, 2012
Link for ACM to serial port added in Linux instruction.
EC Declaration of Conformity added
- Version 2.2 – February 8, 2012
Protocols overview added
Screen dumps updated
- Version 2.3 – February 16, 2012
Novatys planned
- Version 2.4 – February 25, 2012
General information updated
- Version 2.5 – March 1, 2012
Chapter added how to run RFXmngr or RFXflash on Linux.
- Version 2.6 – March 14, 2012
Code tables added
Cresta, UPM added
- Version 2.7 – March 15, 2012
Flash procedure updated
- Version 2.8 – March 31, 2012
Phenix table added
- Version 2.9 – March 31, 2012
AB400 and Phenix address extended
- Version 2.10 – April 16, 2012
Linux USB - tty configuration updated
- Version 2.11 – May 14, 2012
List of supported protocols updated.
- Version 2.12 – June 8, 2012
Chapter added how to run RFXmngr or RFXflash on Mac OS
- Version 2.13 – July 15, 2012
List of supported protocols updated
- Version 2.14 – August 4, 2012
List of enabled protocols influence added
RFXtrx315 added
- Version 2.15 – August 18, 2012
Enabled protocols table changed
- Version 2.16 – August 26, 2012
Rubicon stektermometer added
ATI Remote Wonder II added
- Version 2.17 – August 28, 2012
Table “sensitivity influenced” updated
- Version 2.18 – September 18, 2012
Chapter 2.3 updated: BlindsT0 disables all other protocols
- Version 2.19 – September 25, 2012
RFXFlash version required changed to 4.0.0.0
- Version 2.20 – September 28, 2012
RF range reduction guide added
- Version 2.21 – October 18, 2012
BlindsT2 and BlindsT3 added
- Version 2.22 – October 24, 2012
Sartano added
- Version 2.23 – October 31, 2012

Sensitivity table updated
Version 2.24 – November 7, 2012
Protocol table extended with the protocols to enable for receive
Version 2.25 – November 14, 2012
HE105 switch settings added
Version 2.26 – November 28, 2012
undec on explained
Version 2.27 – December 4, 2012
Use of Lighting4 commands for undec ARC
Brennenstuhl added
Version 2.28 – December 18, 2012
Receiver tab removed from RFXmngr
Version 2.29 – December 27, 2012
Lighting4 receive added
Version 2.30 – January 1, 2013
Raex motor added
Version 3.00 – January 4, 2013
RFXtrx433 Type1/Type2 firmware added
Version 3.01 – February 4, 2013
Supported protocols list updated
Version 4.00 – February 21, 2013
Chapter 8 - Lighting4 screen updated for RFXmngr 11.0.0.0
Known Lighting4 chapter added
Version 4.01 – March 13, 2013
Receive of LaCrosse sometimes influenced by enabled Hideki
Version 4.02 – June 8, 2013
MDREMOTE LED dimmer added
Conrad RSL2 added
Energenie added
Version 4.03 – September 27, 2013
How to find the MDREMOTE ID (chapter 7.6)
WS1200 added
Byron SX Chime added
Version 4.04 – November 15, 2013
Maverick ET-732 added
Alecto SA30 added
Oregon EW109 added
Revolt added
Version 4.05 – December 5, 2013
Blyss command explanation added.
Lighting4 - Mercury added
Lighting5 – dx.com RGB LED controller added
Version 4.06 – December 27, 2013
Chapter 2.2 updated
Version 4.07 – February 10, 2014
Chapter 7.8 added: how to find the dx.com RGB LED strip driver ID
Version 4.08 – March 20, 2014
ARC and Oregon3.0 updated in table 2.4.
Energenie 5-gang 429.950 added
Version 4.09 – April 4, 2014
BlindsT6 - DC106, YOODA, Röhrmotor24 RMF added
Version 4.10 – April 7, 2014
BlindsT7 - Forest added
Version 4.11 – April 28, 2014
RGB LED – clarified AD is LightwaveRF
Version 4.12 – May 21, 2014
Kambrook RF3672 added
RFY protocol added

Somfy programming instructions added
Supported protocol list RFXtrx433 updated.
Protocol list by function added

Version 4.13 – May 31, 2014
Opus TX300/Imagintronix Soil sensor added

Version 4.14 – June 18, 2014
Prega sensor added
Conrad 34911 Lighting4 coding added

Version 4.15 – June 25, 2014
Kambrook, Rubicson, Viking supported in ext firmware
Number of RFY remotes increased from 16 to 30

Version 4.16 – June 29, 2014
RFXmngn cannot be used on Linux

Version 4.17 – July 3, 2014
CoCo GDR2 added

Version 4.18 – July 14, 2014
Opus TX300 link added

Version 4.19 – July 25, 2014
Aoke relay added

Version 4.20 – August 25, 2014
Enabling protocols clarified.

Version 4.21 – September 5, 2014
Meade sensors added
Oregon BTHGN129 sensor added

Version 4.22 – September 18, 2014
Eurodomest added (NL - Action)
Byron MP001 added
WT0122 added
Procedures added to find the Eurodomest and TRC02 ver2 ID

Version 4.23 – September 24, 2014
Proove TSS330 fridge/freezer sensor added

Version 4.24 – October 9, 2014
BlindsT0 added in ext firmware
Alecto WS1700 and compatibles added

Version 4.25 – December 13, 2014
Smartwares radiator valve added
Proove TSS320 sensor added

Version 4.26 – January 2, 2015
SelectPlus200689101 White Chime (Action NL) added

Version 4.27 – January 6, 2015
SelectPlus200689103 Black Chime (Action NL) added

Version 4.28 – January 7, 2015
Proove outdoor sensors 311346 & 311501 added
Etekcity Wireless Remote Control Outlet Switch (US)

Version 5.00 – January 10, 2015
Copyright message updated
License chapter added
RFXmngn information updated

Version 5.01 – February 27, 2015
Chapter 2.5 Lighting4 receive is reduced with HomeEasy EU enabled.
Chamberlain tubular motor added
Sunpery blind motors added
DEA Systems receivers added
Envivo ENV-1348 chime added
Alecto WS4500 added

Version 5.02 – March 18, 2015
1byOne Easy Chime added
BTX blind motors added
Dolat DLM-1 blind motors added
OTIO added

Version 5.03 – March 19, 2015
TFA 30.3160 pool sensor added

Version 5.04 – April 14, 2015
Chapter 4 updated with restrictions on Lighting4
Siemens SF01 LF959RA50/LF259RB50/LF959RB50 extractor hood added
Maplin N78KA added

Version 5.05 – May 2, 2015
Dooya blind motors added
Louvolute one touch motorised blinds added
Alecto WS3500 added

Version 5.06 – May 4, 2015
Current dx.com TRC02 LED drivers have a different protocol and are not supported.

Version 5.07 – June 1, 2015
WH2 temperature humidity sensor added
RGB LED controller <http://www.ebay.com/itm/191481664563> (maybe dx.com 227892)

Version 5.08 – July 31, 2015
Oregon MSR939 added
ESMO blind motors added
Brel blind motors added
Blinds T6 type motors now also supported in Ext firmware
Supported devices table 2.2.2. updated

Version 5.09 – Aug 12, 2015
Luxaflex blind motors added

Version 5.10 – Aug 17, 2015
JVS screen motors added
Livolo NL link added

Version 5.11 – Aug 31, 2015
ASA motors added

Version 5.12– Sept 14, 2015
Home Comfort added

Version 5.13– Oct 2, 2015
Oregon GR101 received in Type1 firmware
Conrad RSL sensors received in Type2 firmware

Version 5.14– Oct 7, 2015
Quotidom blinds motor added

Version 5.15– Nov 06, 2015
Banggood temp-hum sensor added
Legrand CAD radio added

Version 5.16– Nov 26, 2015
Proluxx codes corrected

Version 5.17– Dec 24, 2015
RFXflash procedure updated
Rubicon pool sensor 48.019 added
Inovalley SM80 plant sensor added
Lucci Air fan added

Version 5.18– Jan 1, 2016
1byone Drive Way alarm added

Version 5.19– Feb 6, 2016
Avantek added
ASP blinds motors BlindsT11 added
Maverick ET-733 added
Profiles PAC-326R Belcanto chime added
HQ COCO-20 added

Version 5.20– Feb 18, 2016
BlindsT12 Confexx CNF24-2435 added
IT FA500, PROmax... added
Ext2 fimware overview added in chapter 2
Auriol Z31055B-TX added
Chuango, Eminent security sensors added

Version 5.21– May 6, 2016
Cartelectronic TIC and Encoder added
FAQ chapter added

Version 5.22– May 14, 2016
Corrected: TX95 is using the Rubicson protocol
MDRemote V108 added

Version 5.23– June 10, 2016
Motolux blinds motor added
Auriol H13726, Hama EWS1500, Meteoscan W155/W160, Ventus WS155 added
FAQ updated

Version 5.24– June 21, 2016
Seav TXS4 added

Version 5.25– Aug 6, 2016
ORNO added

Version 5.26– Sept 6, 2016
Added: How to find the SEAV TXS4 ID

Version 5.27– Oct 09, 2016
Westinghouse fan 7226640 added
THN129 added
TFA 30.3056 pool sensor added

Version 5.28– Oct 19, 2016
MCZ pellet stove added
Alecto SA33 added
Smartwares RM174RF smoke detector added

Version 5.29– Nov 27, 2016
SilverCrest 91089 added
Mertik G6R-H4S added
Marquant 943134
MCZ pellet stove instructions added

Version 5.30– Dec 6, 2016
Kerui security sensors added
Screenline added

Version 5.31– Dec 15, 2016
Flamingo smartwares SF501 added

Version 5.32– Jan 02, 2017
Kangtai, Cotech added

Version 5.33– Feb 01, 2017
Cranenbroek added
Unitec 48110 EIM 826 added
SilverCrest 60494 added
WSD10 added

Version 5.34– March 08, 2017
Housegard Origo smoke detector added
Pearl NC-7159 added
Ambient Weather & Froggit F007TH added
TFA 30.3208.02 sensor added

Version 5.35– March 20, 2017
Silverline Premium motor added
Dooya DT82 instructions added

Version 5.36– April 25, 2017
Quigg added
OTIO EHS5050 added
Blyss temperature/humidity sensor 630467 added
Outlook Motion Blinds added

Version 5.37– May 5, 2017
Cartelectronic TIC in Type2 and Ext2

Version 5.38– May 22, 2017
BBSB not in Ext2
Profile Qnect added

Version 5.39– July 28, 2017
Banggood DANIU sensor added
Somfy usage remarks added
Brennenstuhl RC2044 added

Version 5.40– Sept 18, 2017
Blyss temp/hum added in Ext
Cartelectronic Linky added

Version 5.41– Sept 24, 2017
Sonoff RF added
Rollertrol G series added

Version 5.42– Oct 26, 2017
Dooya DC2770, DT52E added

Version 5.43– Nov 1, 2017
A-OK AC127, AC129 added

Version 5.44– Nov 11, 2017
Digoo DG-R8H added

Version 5.45– Nov 23, 2017
SilverCrest 284705 added

Version 5.46– March 2, 2018
Nexa NBA-001 added
Kimex projection screen added

Version 5.47– March 13, 2018
Lighting4 PT2262 EV1527 info added
Tellus Thermo/Hygro sensors 313159 and 313160

Version 5.48– July 28, 2018
Supported Protocols list updated
FunkBus (Gira, Jung, Berker, Insta) added
Nobily rolladenmotor added
LucciAir DC added

Version 5.49– Aug 18, 2018
Supported Protocols list updated

Version 5.50– Sep 26, 2018
Cotech Ekstra temperaturgiver/hygrometer added
Supported Protocols list updated for RFXtrx433XL

Version 5.51– Sep 28, 2018
P1 smart meter connection for the RFXtrx433XL added